

02/2021

Mod: AL1TB/H2-R2

Production code: AE35X2510-DM



ARMOIRES REFRIGEREES

REFRIGERATED CABINETS

ARMADI REFRIGERATI

KÜHLSCHRÄNKE

ARMARIO REFRIGERADO

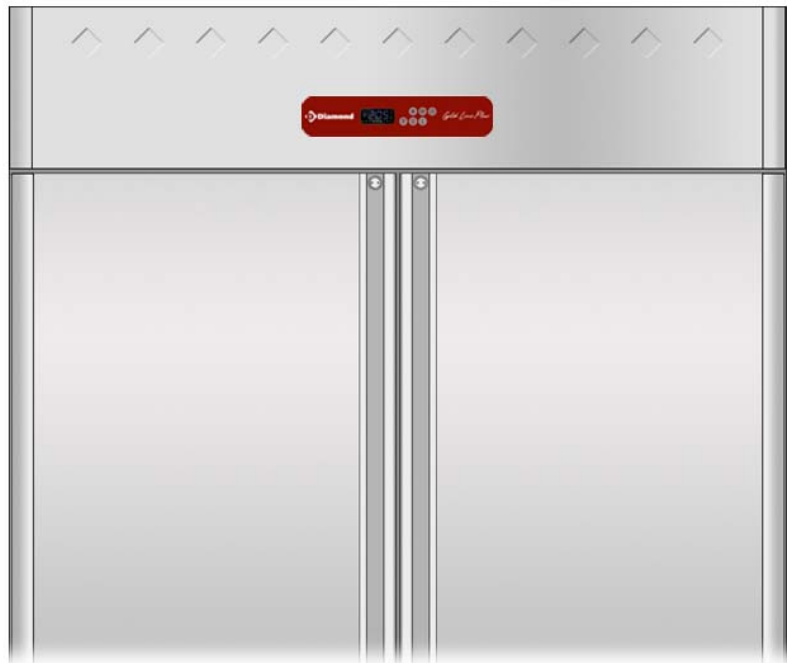

FR

GB

IT

DE

ES

MANUEL D'INSTALLATION D'UTILISATION ET D'ENTRETIEN

INSTALLATION, OPERATING AND
MAINTENANCE INSTRUCTIONS

MANUALE DI INSTALLAZIONE USO E
MANUTENZIONE

INSTALLATIONS, BEDIENUNGS UND
WARTUNGSANWEISUNGEN

MANUAL DE INSTALACIÓN USO Y
MANTENIMIENTO



1. INDEX

1. INDEX.....	1
2. ANALYTICAL INDEX.....	2
3. SAFETY.....	3
4. REGULATIONS AND GENERAL INSTRUCTIONS.....	4
4.1. General information.....	4
4.2. Warranty.....	4
4.3. Replacement of Parts.....	4
4.4. Description of the Appliance.....	5
4.5. Features Plate.....	6
4.6. Personal Protective Equipment.....	7
4.7. Further risks.....	7
5. TRANSPORT AND STORAGE.....	8
5.1. General Information.....	8
5.2. Transport and Handling.....	8
5.3. Storage.....	8
6. INSTALLATION.....	8
6.1. Packaging And Unpacking.....	8
6.2. Installation.....	9
6.3. Electric Power Supply Connection.....	10
6.4. Inspection.....	11
7. USE AND FUNCTIONING.....	11
7.1. Description of Controls.....	11
7.2. Viewing the LED Display.....	12
7.3. Functions.....	13
7.4. Recommendations for Use.....	16
8. CLEANING AND MAINTENANCE.....	17
8.1. Recommendations for Cleaning and Maintenance.....	17
8.2. Routine Maintenance.....	18
8.3. Routine Maintenance (350+350).....	18
8.4. Extraordinary Maintenance.....	18
8.5. Maintenance intervals.....	19
9. FAULTS.....	20
9.1. Alarms Display.....	21
9.2. Faults Display.....	22
10. TECHNICAL NOTES.....	22
10.1. Accessory wheels assembly kit.....	22
10.2. Reversibility of the Doors.....	23
10.3. Parameter settings.....	26
11. DISPOSAL OF THE APPLIANCE.....	27
11.1. Waste storage.....	27
11.2. Equipment disassembly procedure.....	27
12. TECHNICAL DATA SHEET REFRIGERANT R134a / R452A.....	28
13. TECHNICAL DATA SHEET REFRIGERANT R290.....	28
ATTACHMENTS.....	I

2. ANALYTICAL INDEX

A

Accessory wheels assembly kit; 22
Alarms Display; 21

C

Cancelling the list of HACCP alarms; 15
Compressor operating hours; 15

D

Description of Controls; 11
Description of the Appliance; 5
DISPOSAL OF THE APPLIANCE; 27

E

Electric Power Supply Connection; 10
Enabling / Disabling the Overcooling function; 13
Enabling manual defrost; 13
Enabling the Energy Saving function; 13
Enabling the function for high or low humidity; 13
Extraordinary Maintenance; 18

F

FAULTS; 20
Faults Display; 22
Features Plate; 6
Functions; 13
Further Risks; 7

G

General information; 4
General Information; 8

H

HACCP Alarms; 14
HACCP alarms display; 14

I

Inspection; 11
Installation; 9

L

Load Disposition; 16
Locking the keyboard; 13

M

Maintenance intervals; 19

P

Packaging; 8
Parameter settings; 26
Personal Protective Equipment; 7
Prolonged Inactivity; 17

R

Recommendations for Cleaning and Maintenance;
17
Recommendations for normal use; 17
Recommendations for Use; 16
Replacement of Parts; 4
Reversibility of the Doors; 23
Routine Maintenance; 18
Routine Maintenance (350+350); 18

S

SAFETY; 3
Setting the time and date; 13
Setting the working setpoint; 13
Storage; 8
Switching the appliance On and Off; 13
Switching the cold room light On / Off; 13

T

TECHNICAL DATA SHEET REFRIGERANT
R134a / R452A; 28
TECHNICAL DATA SHEET REFRIGERANT
R290; 28
Transport and Handling; 8

U

Unpacking; 8



V

Viewing the LED Display; 12
Viewing the temperature probes; 14

W

Warranty; 4

3. SAFETY

  **It is recommended to carefully read the instructions and warnings contained in this manual before using the appliance. The information contained in the manual is fundamental for the safety of use and for machine maintenance.**

 Keep this manual carefully so that it can be consulted when necessary.

 The electric plant has been designed in compliance with the **IEC EN 60335-2-89** Standard.

 The installation, extraordinary maintenance and disposal of the equipment must be carried out by specialised personnel.

 **Warning:** R290 cooling gas is potentially flammable and explosive. Every possible safety precaution must be taken to avoid any danger. The installation, non-routine maintenance and disposal of the equipment must be handled by qualified professionals.

 The sound pressure level emitted by the equipment is less than 70dB (A). The value may increase depending on the workplace where it is measured.

 Maintain ventilation openings in the appliance casing or in the built-in structure free from all obstructions.

 Do not use mechanical devices or other means to accelerate the defrosting process, other than those recommended by the manufacturer.

 Do not damage the coolant circuit.

 Do not use electrical appliances inside the appliance compartments for storage of frozen food.

 Do not store explosives, such as pressurised containers with flammable propellant, in this unit.

 Do not place anything on the bottom of the device. Use the appropriate racks to store the product.

 The maximum permissible load for the racks is 45kg evenly distributed.

 The supply cable must be replaced by qualified personnel.

 Specific adhesives highlight the presence of mains voltage in the proximity of areas (however protected) with risks of an electrical nature.

 If a stationary appliance is not fitted with a supply cord and a plug, the means for disconnection must be incorporated in the fixed wiring in accordance with the wiring rules.

 In the design and construction phase, the manufacturer has paid particular attention to the aspects that can cause risks to safety and health of persons that interact with the appliance.

 Carefully read the instructions stated in the manual and those applied directly to the machine, and particularly respect those regarding safety.

 Do not tamper with, evade, eliminate or by-pass the installed safety devices. Failure to comply with this requisite can lead to serious risks for personal health and safety.

 It is recommended to simulate some test manoeuvres to identify the controls, in particular those relative to switch-on and switch-off and their main functions.

 The appliance is only destined for the use for which it has been designed; any other use must be considered improper.

 The manufacturer declines all liability for any damage to objects or injury to persons owing to improper or incorrect use.

 All maintenance interventions that require precise technical skill or particular ability must be performed exclusively by qualified staff.



The safety devices must be subjected to periodic inspections as indicated in the chapter on extraordinary maintenance.



In order to guarantee hygiene and protect the foodstuffs from contamination, the elements that come into direct or indirect contact with the foodstuffs must be cleaned very well along with the surrounding areas. These operations must

only be performed using detergents that can be used with foodstuffs, avoiding inflammable products or those that contain substances that are harmful to personal health.



In the case of prolonged inactivity, as well as disconnecting all the supply lines, it is necessary to accurately clean all internal and external parts of the appliance.

4. REGULATIONS AND GENERAL INSTRUCTIONS

4.1. General information

This manual has been designed by the manufacturer to provide the necessary information to those who are authorised to interact with the appliance.

It is advisable for the receivers of the information to read it carefully and apply it strictly.

Reading the information contained in this document will allow the user to prevent risks to personal health and safety.

Keep this manual for the entire operating life of the appliance in a place, which is well known and easily accessible, so that it is always available when its consultation becomes necessary.

Particular symbols have been used to highlight some parts of the text that are very important or to indicate some important specifications. Their meanings are given below:



Indicates important information regarding safety. Behave appropriately so as

not to risk the health and safety of persons or cause damage.



Indicates particularly important technical information that must not be ignored.

The equipment has been designed for the refrigeration of food. Any other use is considered improper.



- The equipment is not intended for use by:
- persons whose physical, sensory or mental capabilities are impaired.
 - children
 - persons with a lack of experience and/or knowledge of the product/process.



The equipment is not suitable for installation outdoors and/or in environments subject to the action of atmospheric agents (sun, rain, etc.).

4.2. Warranty

The warranty of the appliance and the components we produce has duration of 2 years from the date of delivery and translates into the supply, free of charge, of parts that we consider to be faulty.

These faults must, however, be independent from incorrect use of the product in compliance with the indications stated in the manual.

Fees deriving from labour, journeys and transport are excluded from the warranty.

The materials replaced under warranty are our property and must therefore be returned under the responsibility and expense of the customer.

4.3. Replacement of Parts



Activate all envisioned safety devices before carrying out any replacement intervention.



In particular, deactivate the electrical power supply using the differential isolating switch.

Only use original spare parts to replace worn components.



The manufacturer is not liable for damage or malfunctions caused by:

- non-compliance with the instructions in this manual;

- repairs not performed in a workmanlike manner;
- use of non-original spare parts;
- interventions by non-skilled technicians;
- unauthorised intervention;
- lack of preventive maintenance;
- improper use of the equipment
- unforeseeable events

- use of the equipment by insufficiently trained staff
- non-application of the safety and hygiene regulations in force in the country of use.

We accept no liability for damage caused by conversions and/or modifications made by the end user.

4.4. Description of the Appliance

The refrigerated cabinet, from now on defined as appliance, has been designed and built to preserve foodstuffs in the professional catering ambit.

- 1) condensation area:** it is positioned in the upper part and is characterised by the presence of the condensing unit.
- 2) electric area:** it is positioned in the upper/front part and contains the control and power supply appliance as well as electric wiring.
- 3) evaporation area:** it is situated inside the refrigerated chamber and is characterised by the evaporating unit.
- 4) storage area:** it is situated under the evaporating unit and is destined for preservation of foodstuffs.

The upper part is distinguished by a dashboard that allows accessibility to the electric parts. In the front part there are one or more vertically-opening doors, which close the refrigerated compartment hermetically.

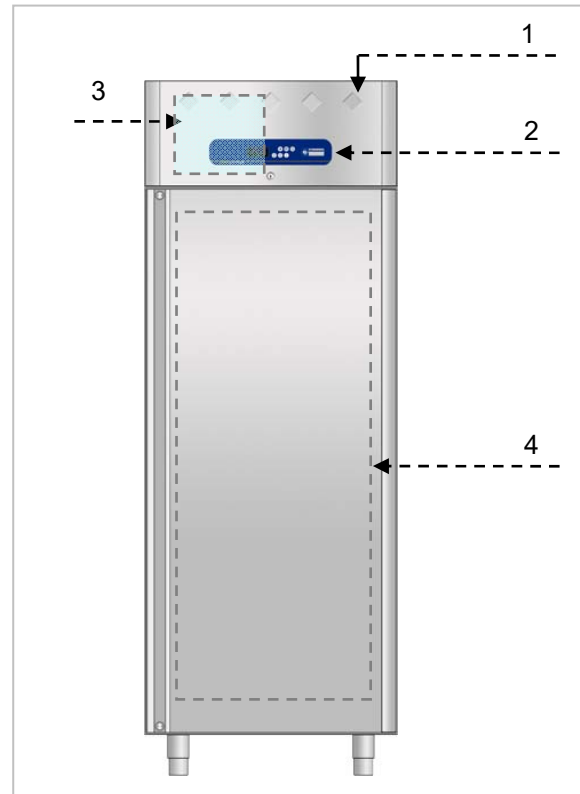

Depending on requirements, the appliance is produced in several versions:

Positive Temperature CABINET

(-2°C +8 °C) (0°C +10 °C)

Ventilated model suitable for preservation of fresh foodstuffs, packed pre-cooked foods and beverages. The period of preservation must be intended as quite limited.

Negative Temperature CABINET

(-15°C -25 °C) (-20°C -10 °C)

Ventilated model suitable for the preservation of deep-frozen products for long periods of time.

Static CABINET for FISH

(-4°C + 6°C)

Static model suitable for the preservation of fresh fishery products for brief periods of time.





This model is also indicated for the preservation of products whose components undergo oxidation in the

presence of ventilation (e.g. cream in confectionery products)

4.5. Features Plate

The identification plate shown is applied directly onto the appliance. It states the references and all indications indispensable for working in safety.

- 1) Equipment code
- 2) Equipment description
- 3) Serial number
- 4) Power supply voltage and frequency
- 5) Rated power
- 6) Defrosting output
- 7) Total lamps output
- 8) Climate Class
- 9) Type and Quantity of Cooling Gas
- 10) Number of the refrigerant of the main component of the foam insulation gas
- 11) WEEE mark

		2018
Code Kode Codice	XXXXXXXX	①
Descrizione / Description	Xxxxxxxxxx Xxxxxxxxx	②
Serial No./ Serien Nr./ Matricola	XXXX.XXXX	③
Tension / Spannung / Tensione	xxx V~ xx Hz	④
Input / Leistungsaufnahme / Potenza	xxx W xxx A	⑤
 Defrost Power / Potenza Sbrinamento	xxx W	⑥
Climate Class / Klimaklasse / Classe Climatica	5	⑧
Refrigerant Kuehlmittel Refrigerante	xxxx xxxx Kg	⑨
Insulation Isolierung Isolamento	HFO1233zd	⑩
  		⑪
Max  xx W		⑦

The climate class described on the identification plate refers to the following values:

Blind door models

Climate Class	EN 60335-2-89	EN ISO 23953	
	Room Temperature	Room Temperature	Relative Humidity
5	43°C	40°C-	40%

Glass door models

Climate Class	EN 60335-2-89	EN ISO 23953	
	Room Temperature	Room Temperature	Relative Humidity
4	32°C	30°C-	55%

4.6. Personal Protective Equipment

The identification and selection of appropriate personal protective equipment is the responsibility of the employer or workplace manager or service technician.

Operators are required to wear the identified equipment.

Durante l'uso ordinario, i guanti proteggono le mani dalla teglia fredda.

Di seguito l'elenco dei principali dispositivi di protezione individuale (DPI) da utilizzare durante le varie operazioni di lavoro.

Task	Protective clothing	Safety shoes	Gloves	Glasses	Helmet or hard hat
Transport and handling		■	□		□
Unpacking		■	□		
Assembly		■	□		
Ordinary use	■	■	□		
Ordinary cleaning	□	■	■	□	
Extraordinary cleaning	□	■	■	□	
Maintenance	□	■	□		
Dismantling	□	■	□		
Scrapping	□	■	□		

■ Mandatory personal protective equipment (MPPE)

□ Personal protective equipment (PPE) to be used if necessary

4.7. Further risks

The proper design of the equipment and the installation of adequate protection do not completely exclude risks to the operator.

This manual lists the personal protective equipment to be used by the operator.

Sufficient space is provided during the installation of the equipment to limit the risks. To maintain

these conditions, the areas surrounding the equipment must be kept clean, dry, well lit and free of obstacles.

The following is a list of possible risks that may still occur.

Possible risks	Description
Slip or fall	The operator may slip due to water, oil or dirt on the floor.
Burns Abrasion	The user intentionally or unintentionally touches certain components inside the appliance (e.g. cold pans, cooling fins and cooling circuit tubes) without wearing protective gloves.
Electrocution	Contact with live electrical parts during maintenance operations performed without disconnecting the power supply.
Fall	The operator intervenes on the equipment using unsuitable means to access the upper part.
Injuries	The upper control panel may not be secured properly by qualified personnel. It may close abruptly.
Tipping	During equipment and packaging handling operations using unsuitable lifting and/or handling equipment or with an unbalanced load
Cooling gas	Inhalation of cooling gas. The type of refrigerant can be found on the equipment's identification plate.

5. TRANSPORT AND STORAGE

5.1. General Information

The equipment must be transported and handled using appropriate means with adequate capacity.

 During transport and handling of the equipment, it is strictly forbidden to stack one machine on top of the other, in order to exclude the risk of loads tipping over due to stacking.

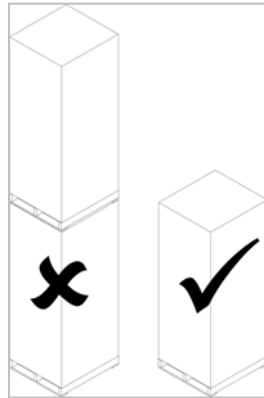

 The equipment must only be transported, handled and stored by skilled staff. Minimum requirements for skilled staff are as follows:

- specific technical training and experience in the use of lifting systems;
- knowledge of safety regulations and applicable laws;
- knowledge of general safety requirements;
- respect for the use of personal protective equipment in accordance with the operation performed;
- the ability to identify in advance and avoid any possible danger.

5.2. Transport and Handling

 It is forbidden to stand under suspended loads during handling and transport. Unauthorised personnel may not enter the work area. The transported load can move when braking, accelerating, cornering and on rough roads.

 The equipment must be handled in a vertical position. It is forbidden to move the equipment in a horizontal position. If the equipment is handled in a horizontal position, wait a few hours before operating it.

For the correct performance of lifting operations, use the most suitable type of equipment in terms of characteristics and load capacity: forklift or transpallet.

 Avoid pushing or dragging the equipment when handling it.

 Before lifting, secure the surrounding area and prevent access to personnel. Move the equipment to a minimum height above the ground and ensure the stability of the load.

 Do not lift the equipment in any other way than explained in this manual. Before placing the load, check that the floor is level and has sufficient load-bearing capacity to support the weight of the load.

5.3. Storage

 The equipment must be stored in a non-aggressive, vibration-free environment.

 The room temperature should be between -10°C and +50°C. Avoid excessively humid environments. The storage place must have an

adequate support surface to prevent deformation of the machine or damage to the support feet.

 Only skilled staff is allowed to perform positioning, assembly and disassembly of the equipment.

6. INSTALLATION

6.1. Packaging And Unpacking

Move and install the appliance respecting the information provided by the manufacturer, shown directly on the packaging, on the appliance and in this manual.

 Wear protective gloves before unpacking.

 Avoid pushing or dragging the equipment to avoid risks of tipping over and damage to the structure.

The lifting and transportation system of the packaged product envisages the use of a fork-lift truck or a pallet stacker, using which particular attention must be paid to balancing the weight in order to prevent the risk of overturning (avoid excessive tilting!).

 **ATTENTION:** When inserting the lifting device, pay attention to the gas supply pipe and the position of the feet.

 **ATTENTION:** given the presence of weights concentrated in the high part of the appliance, do not drag the appliance during movements (tipping hazard and damage to feet).

The packaging is made of cardboard and the pallet of wood. A series of symbols is printed on the cardboard packaging that highlights, in accordance with international standards, the provisions, which the appliances must be subject to during loading, unloading, transportation and storage.



6.2. Installation

 Installation and assembly operations must be carried out by qualified personnel. If the equipment uses R290 cooling gas, every possible precaution must be taken to avoid any danger linked to the flammability of this gas.

 All the installation phases must be considered, from the moment of creation of the general plan.

 Installation and assembly operations must be carried out in accordance with current safety regulations.

On delivery, check that the packaging is intact and has not suffered any damage during transportation.

Any damage must be notified to the transportation company immediately.

The appliance must be unpacked as soon as possible to check that it is intact and undamaged.

Do not cut the cardboard with sharp tools in order to prevent damage to the steel panels underneath.

Pull the cardboard packaging upwards.

After having unpacked the appliance, check that the features correspond to those requested in the order;

For any anomalies, connect the dealer immediately.

 On stainless steel equipment, carefully remove the protective film from the inner and outer walls, avoiding the use of metal tools.

If adhesive remains on the walls of the machine, remove it using a non-corrosive solvent; rinse and dry thoroughly after cleaning. It is advisable to apply a protective oil layer to all steel surfaces.

 Packaging elements (nylon bags, polystyrene foam, staples ...) must not be left within reach of children.

Remove the protective PVC film from the internal and external walls, avoiding the use of metal tools.

 Packaging must be disposed of in accordance with the regulations in force in the country where the equipment is used.

 The equipment used for installation and assembly operations must comply with current safety standards.

The installation area must be equipped with all power supply and production residue drainage connections and must be suitably lit and respect current laws regarding hygiene and sanitary requirements.

 To optimise consumption and reduce wear of the machine, do not position it near heat sources or in environments where temperatures are too high.

Proceed with machine levelling, adjusting the individual feet.



It is essential that the equipment is level; otherwise, the operation of the machine may be impaired

Install the equipment so that the workstation is positioned in front of the control panel.



Do not push or drag the appliance during installation to avoid it toppling over or causing damage to parts or persons.



This appliance can only be installed and operate in rooms, which are permanently ventilated, in order to guarantee correct operation.



Connect and leave for a certain period of time (at least 2 hours) before checking

functioning. During transport, it is probable that the compressor lubricant oil has entered the refrigerant circuit blocking the capillary: therefore, the appliance will function for a certain period without producing cold until the oil has returned to the compressor.



The size of the compartment that houses the equipment must be such as to avoid excessive concentrations of gas in the event of a leak from the refrigeration circuit and in any case, the compartment must have a free area NEVER smaller than 4 times the space occupied by the equipment. Adequate space must be provided to ensure effective escape routes at all times. The above-mentioned compartment must be well ventilated.



ATTENTION: the appliance requires the minimum functioning spaces as shown in the diagram.

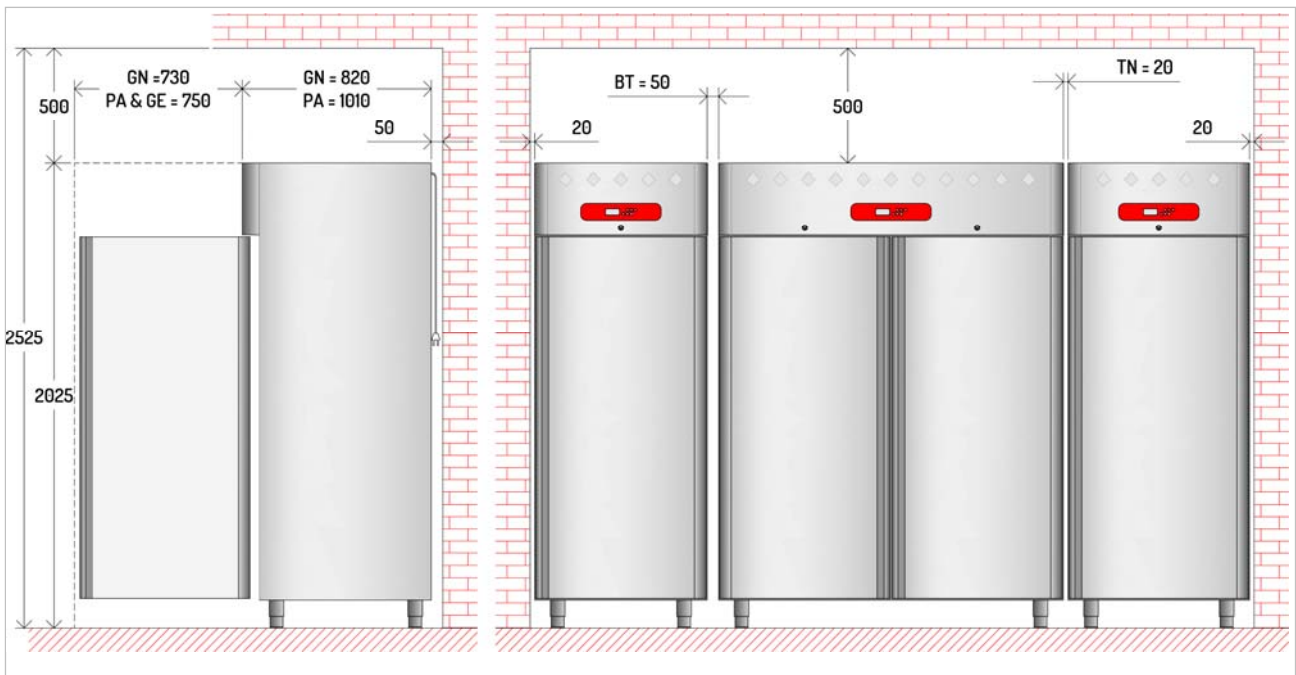

6.3. Electric Power Supply Connection

Connection must be carried out by authorised and qualified staff, respecting the current laws regarding the subject and using appropriate prescribed material.



Before connecting the appliance to the electric mains check that the voltage and the frequency correspond to the data stated on the registration plate applied on the rear of the appliance.





The equipment is supplied with one of the following operating voltages:

- 230V 1~ 50Hz
- 220V1~ 60Hz.





Provide an earthed socket with a capacity appropriate to the absorption indicated on the identification plate.

 It is forbidden to operate the equipment connected to an ungrounded system.

 For direct connection to the power supply, a device must be provided to ensure disconnection from the power supply, with a contact-opening distance allowing complete disconnection under the conditions of overvoltage category III, in accordance with the installation rules.

 Refer to the technical data on the identification plate for the correct sizing of the switch.

 The switch-disconnector must be located close to the equipment, must be visible to the operator and must be indicated by an information sign.

 If a plug is used, it must comply with national installation regulations.

 The plug must be accessible even after the equipment has been placed in the installation location.

 The plug must always be visible to the operator performing the maintenance operation.

After the electrical connection, check that the supply voltage, when the equipment is running, does not deviate from the nominal value given on the specifications plate $\pm 10\%$.

The power cable used for connection to the mains supply is of type H05VV-F; when replacing it, use a cable with the same or better characteristics.

 When replacing the power cable, the earth conductor must be kept longer than the active conductors.

 The replacement of a damaged power cable must be done by a qualified technician in order to prevent any possible risk.

6.4. Inspection

The appliance is delivered in conditions that it can be started-up by the user. This functionality is guaranteed by passing the tests (electric inspection - functional inspection,

appearance inspection) and relative certification through the specific attachments.

7. USE AND FUNCTIONING



7.1. Description of Controls



ON ... OFF Key

Pressing the **ON/OFF** key makes the controller switch-on. Press the key for 2 consecutive seconds to switch off the controller.



SET Key

Pressing this once during normal operation allows you to set the working setpoint.



Defrost Key

Pressing this key once during normal operation, allows you to start manual defrost.



Light Key

Pressing this key once during normal operation, allows you to turn the light on and off.



Increase ... Decrease Key

Pressing these keys during setpoint programming, parameters and humidity increases or decreases the selected value.

7.2. Viewing the LED Display

There are a number of graphic signals within the display area.



This LED indicates the state (on or off) of the COMPRESSOR



This LED indicates the activation of the ENERGY SAVING function



This LED indicates the state (on or off) of the FAN



This LED indicates that defrosting is in progress



This LED indicates the state (on or off) of the LIGHT



This LED indicates an HACCP state of alarm.



This LED indicates the state (on or off) of the DOOR RESISTANCES



This LED indicates an HACCP state of ALARM / FAILURE.



This LED indicates the activation of the OVER COOLING function



THE LED lights require cleaning of the condenser filter.

GB

7.3. Functions

Switching the appliance On and Off

Make sure the keyboard is not locked. Hold the



key down for two seconds: the  led will turn on / off.

Setting the working setpoint

Make sure the keyboard is not locked. Press and



release the key: the  led will flash. Set

the new working setpoint with  and .

Confirm the new value with .

Switching the cold room light On / Off

Make sure the keyboard is not locked. Press and



release the key: the  led will turn on.

To turn the light off press the  key again.

Enabling / Disabling the Overcooling function

Make sure the keyboard is not locked. Press the





button for at least 4 seconds. The  will turn on. During the Overcooling function the setpoint is increased by 1°C. During the Overcooling function defrost is never enabled.

Enabling manual defrost

Make sure that the keyboard is not locked and that the Overcooling function is not in progress.



Press the button for at least 4 seconds. If the temperature of the evaporator probe is not greater than the set limit, the defrost function is enabled and the  led will turn on. When defrost is finished the  led will turn off.

Enabling the Energy Saving function

Once the established time is over without opening the doors, the Energy Saving function is enabled :

the  led will turn on. The function stops the first time the door is opened.

Enabling the function for high or low humidity

Make sure the keyboard is not locked.

To view the current function press and release the





keys : the screen displays "rhH" if the function for high percentage of humidity is enabled, "rhL" if the function for low percentage of humidity is enabled.

To change the function press the  and



keys for at least 4 seconds: the screen displays "rhH" (high percentage of humidity function) or "rhL" (low percentage of humidity function).

Locking the keyboard





To lock the keyboard press the  and  keys for at least 1 second: the screen displays "Loc" for 1 second. If the keyboard is locked, it will not be possible to perform any operation: any operation will cause the word "Loc" to appear on the display screen. To unlock the keyboard press

the  and  keys for at least 1 second: the screen will display "UnL" for 1 second.



Setting the time and date



Make sure the keyboard is not locked.



Press the  key for 1 second: the screen displays the letters "rtc".



Press and release the  key: the screen will display "yy" followed by the last two numbers of the year and the  LED will flash. With the keys  and  it is possible to set the current year.



Press the  key to memorise the date and move on to changing the month: the screen will

display "nn" followed by the two numbers of the month. With the keys  and  it is possible to set the current month.

Press the  key to memorise the date and move on to changing the day: the screen will display "dd" followed by the two numbers for the day. With the keys  and  it is possible to set the current day.

Press the  key to memorise the date and move on to changing the time: the screen will display "hh" followed by the two numbers for the hour. With the keys  and  it is possible to set the current hour.

Press the  key to memorise the entry and move on to changing the minutes: the screen will display "nn" followed by the two numbers of the minutes. The time is displayed in a 24 hour format. Using the  and  keys it is possible to set the correct value.



Press and release the  key or do not operate for 15 seconds: the  LED will turn off. To exit the procedure early press and release the  key.

Viewing the temperature probes

Make sure the keyboard is not locked.

Press the  key for 1 second: the screen displays the letters "rtc".

Press the  key: the screen will display the temperature read by the cold room probe.

Press the  key: the screen displays the letters "Pb2" (evaporator probe). Press the  key to view the value read by the evaporator probe.

Press the  key: the screen displays the

letters "Pb3" (condenser probe). Press the  key to view the value read by the condenser probe.

To exit the procedure press the  key: the screen will display the temperature read by the cold room probe again.

HACCP Alarms

The tool is capable of memorising up to 9 HACCP alarms, after which the most recent alarm will over-write the old one. The tool provides the following information:

- alarm code
- the critical value
- the date and time when the alarm was set off
- the duration of the alarm (from 1 min to 99 h and 59 min, partial if the alarm is in progress).

The following alarm codes are available:

- **AL** : minimum temperature alarm
- **AH** : maximum temperature alarm
- **id** : door microswitch input alarm
- **PF** power failure alarm

 To avoid having to memorise power failure alarms repeatedly, disconnect the power supply when the tool is off



 If the duration of the power failure alarm is such that it causes a clock error (code "rtc"), the tool will not provide any information regarding the duration of the alarm

HACCP alarms display

Make sure the keyboard is not locked.

Keep the  key pressed for 1 second: the screen will display the letters "rtc".

Press the  key repeatedly until the letters "LS" appear.

Press the  key: the screen will display the code for the most recent alarm (in other words one of the codes listed above followed by number "1"; the greater the number that follows the code  for the alarm, the older it is). With the  and



keys it is possible to scan the various memorised alarms.



To select an alarm press the key: the **HACCP** led will stop flashing and stay on steadily, the screen will display the following information in sequence :

8.0	the critical value is 8.0 °C/8 °F
StA	the screen is about to display the date and time when the alarm was set off
y09	the alarm was set off in 2009 (continue ...)
n03	the alarm was set off in the month of March (continue ...)
d26	the alarm was set off on March 26, 2009
h16	the alarm was set off at 16:00 (continue ...)
n30	the alarm was set off at 16:30 (continue ...)
dur	the screen will display the duration of the alarm
h01	the alarm lasted for 1 h (continue ...)
n15	the alarm lasted for 1 h and 15 min
AH3	the selected alarm

The screen displays every piece of information for 1 second.

To exit the sequence of information: press and



release the key, the screen displays the selected alarm ("**AH3**" in the example).



To exit the procedure press the key: the screen will display the temperature read by the cold room probe again.



If the tool does not have any alarms in its memory, the "**LS**" label will not be displayed.

Cancelling the list of HACCP alarms

Make sure the keyboard is not locked.



Keep the key pressed for 1 second: the screen will display the letters "**rtc**".



Press the key repeatedly until the letters "**rLS**" appear.



Press the key: the password will be requested in order to cancel the alarms from the memory.



With the and keys enter the



password **149** : press the key to confirm the deletion of the alarms.



If the tool does not have any alarms in its memory, the "**rLS**" label will not be displayed.

Compressor operating hours

The tool is capable of memorising up to 9,999 hours of compressor operation, after which the number "9999" will flash.

To view the hours of compressor operation follow the instructions below.

Make sure the keyboard is not locked.



Keep the key pressed for 1 second: the screen will display the letters "**rtc**".



Press the key repeatedly until the letters "**CH**" appear.



Press the key to view the data. To reset the counter to zero follow the instructions below.

Make sure the keyboard is not locked.



Keep the key pressed for 1 second: the screen will display the letters "**rtc**".



Press the key repeatedly until the letters "**rCH**" appear.



Press the key: the password is required in order to reset the counter to zero.



With the and keys enter the password **149** :



press the key to confirm.

7.4. Recommendations for Use

Load Disposition

Distribute the product evenly inside the compartment (away from the door, the lateral sides and the back) to allow good air circulation.

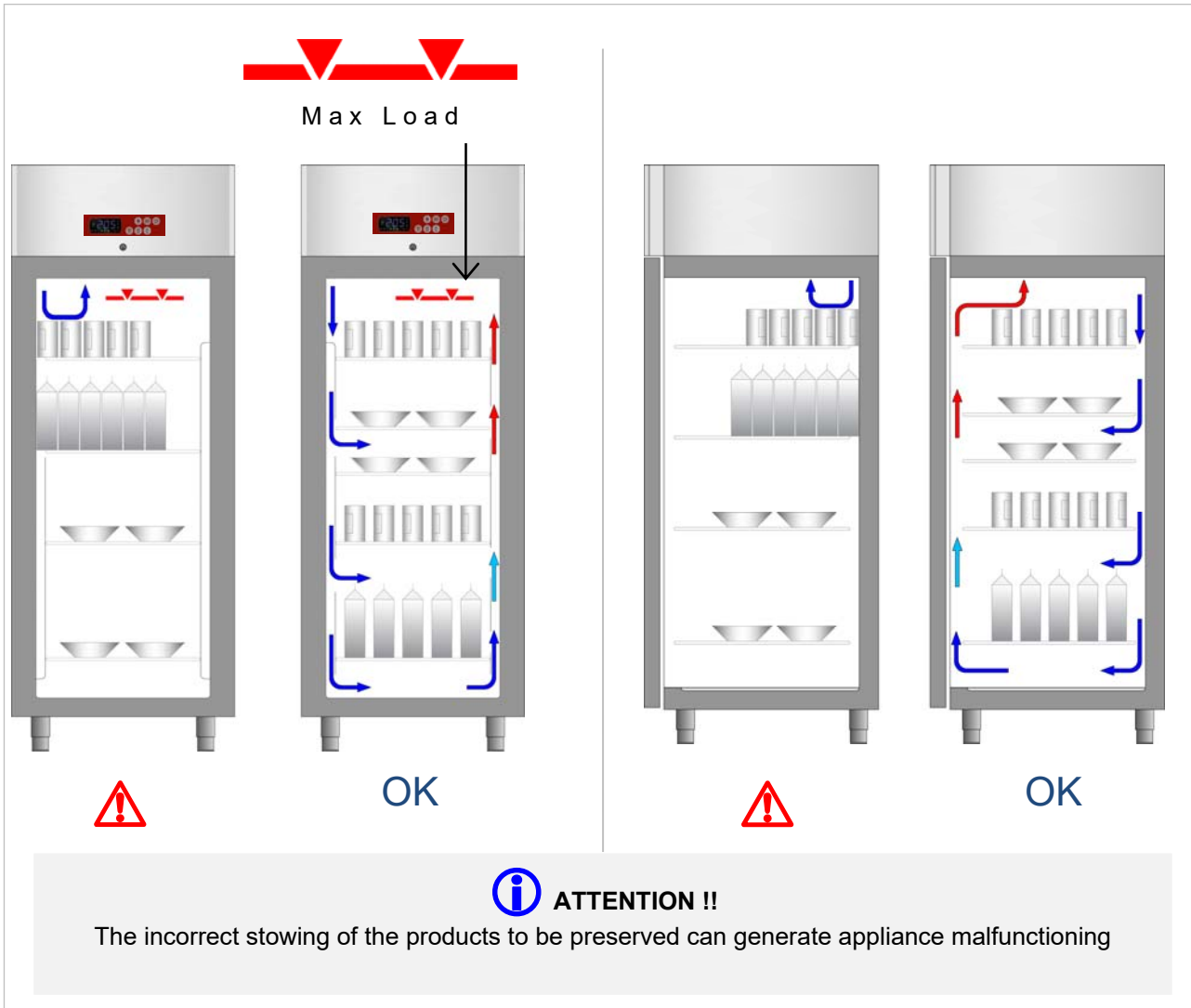

Prolonged Inactivity

If the appliance remains inactive for a long period, proceed as follows:

1. Use the automatic disconnecting switch to deactivate connection to the main electrical line.
2. Clean the appliance and surrounding areas thoroughly;
3. Spread a thin layer of cooking oil onto the stainless steel surfaces;
4. Carry out all maintenance operations;
5. Leave the doors ajar to prevent the formation of mould and/or unpleasant odours.

Recommendations for normal use

In order to ensure correct use of the appliance, it is advisable to apply the following recommendations:

- Do not obstruct the front and rear zones above the condensing unit in order to favour heat disposal from the condenser to a maximum.
- Always keep the front of the condenser clean using a soft brush and do not use rigid or metal tools that may damage the condenser fins.
- Check the planarity of the appliance rest surface.
- Do not introduce liquid or solid substances at temperatures above the environmental temperature and, however, introduce the material after the appliance has reached the functioning temperature.
- Do not stack the materials to be preserved in contact with the internal walls, so blocking the circulation of air, which guarantees uniformity of the internal temperature of the refrigerated compartment.
- Limit the number of times and the duration of time the doors are open to a maximum.

8. CLEANING AND MAINTENANCE

8.1. Recommendations for Cleaning and Maintenance



Activate all envisioned safety devices before carrying out any maintenance interventions. In particular, deactivate the electrical power supply using the automatic isolating switch. During maintenance, the cable and plug must be visible to the operator performing the operation. Do not touch the equipment with wet or damp hands or bare feet.

Do not remove safety guards.

Use appropriate personal protective equipment.

During maintenance, there are still some risks that cannot be avoided and which must be neutralised by adopting appropriate behaviour.

It is forbidden to carry out inspection, cleaning and/or maintenance operations on moving parts.

8.2. Routine Maintenance

Routine maintenance consists of daily cleaning of all the parts which can come into contact with foodstuffs.

Correct maintenance allows the user to maximise performance levels and operating life and constantly maintain safety requirements.

Do not spray the appliance with direct jets of water or high pressure appliances.

When cleaning stainless steel, do not use iron wool, brushes or scrapers as ferrous particles could be deposited which, on oxidising, could lead to rust.

To remove hardened residues, use wooden or plastic spatulas or abrasive rubber pads.

During long periods of inactivity, spread a protective layer on all stainless steel surfaces by wiping them with a cloth soaked in Vaseline oil and airing the rooms periodically.



Do not use products which contain substances which are harmful and dangerous for personal health (solvents, petrol etc.).

8.3. Routine Maintenance (350+350)

In these models, the two cells have a different cooling and defrosting system.

In the upper ventilated cell, defrosting takes place automatically at regular periods by the passage of hot air. The condensation that is formed is conveyed into the appropriate tank under the compressor and then evaporated. No operation is therefore required by the user.

In the lower static cell, defrosting takes place by stopping the machine and frequency is at the user's discretion.

Perform the operations stated below:

1. Switch the lower compartment off by acting on the relevant switch
2. Empty the cell, removing the products contained
3. Leave the door open for the time necessary until the ice formed on the walls melts; if necessary, ease detachment from the walls using the appropriate scraper supplied.
4. Clean well, dry the cell and reposition the cap before re-starting the appliance.

ATTENTION : To ease evacuation of the water from the bottom, remove the cap and at the end of the operation empty the collection tray positioned under the cabinet as shown in the layout.

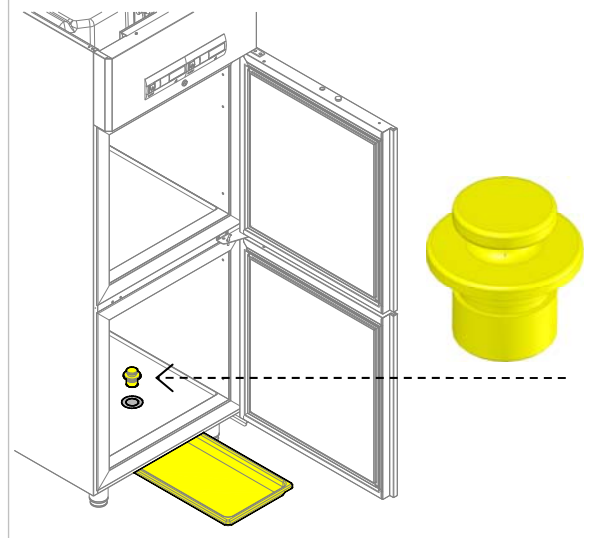

8.4. Extraordinary Maintenance



Extraordinary maintenance operations must be carried out by skilled technical staff, equipped with all personal protective devices.



It is forbidden to remove or tamper with guards and safety devices while the machine is running.



Procedures for topping up the refrigerant and repairing gas leaks may only be carried out by personnel who meet all the requirements of the

regulations in force in the country where the equipment is used.



In the case of flammable refrigerant gases, R290, R600a or other hydrocarbons, disconnect the machine from the power supply and completely purge the refrigerant circuit with an inert gas before proceeding with welding or other work requiring flames or sparks.



For refrigerant gases such as R452A, R134a or other greenhouse gases comply with the

regulations in force concerning the handling of Fgas.



In the event of hazardous situations being observed, e.g. damage and exposure to sharp objects, damage to electrical or thermal insulation, the equipment must not be operated or used and must be secured as soon as possible, preventing access to the surrounding area if necessary.



Periodically have the following operations carried out by specialised staff:

- Periodically clean the condenser using suitable tools (suction device or soft brushes).

- Check the perfect sealing of the door gaskets and replace them if necessary.
- Periodically clean the condensate evaporation tray.
- Check that the electric connections have not loosened.
- Check the efficiency of the heating element (in BT models).
- Check functioning of the remote-thermostat or cards and probes.
- check the efficiency of the electrical system.

8.5. Maintenance intervals









In order to assure constant efficiency of the equipment, it is advisable to inspect the equipment at intervals indicated in the following table:

Operation	Description	Interval
Routine cleaning	General cleaning of equipment and surrounding work area	daily
Mechanical protections	Inspection of the state of preservation of the external mechanical parts; check for any deformation, loosening or removal	monthly
Control	Check of the mechanical part; check for cracks or deformations; check for tightness of screws; check of the state of preservation of the stickers and danger/information symbols.	yearly
Machine structure	Check tightness of screws, main fasteners, etc.	yearly
Safety signs	Check legibility and state of preservation of signs	yearly
Electrical panel	Checking the state of preservation of electrical components and wiring between the switchboard and electrical components.	yearly
Connecting cable, socket and plug	Check the state of preservation of components (replace if necessary)	yearly
General equipment inspection	Complete general inspection of the equipment	10 years





9. FAULTS

The information shown below aims to help with the identification and correction of any anomalies and malfunctions which could occur during use. Some of these problems can be resolved by the

user. For the others, precise competency is required and they must therefore only be carried out by qualified staff.

Problem	Causes	Solutions
The refrigerator unit does not start	End of defrosting	it starts after a pause of 3 minutes
	Switch-off by means of master switch	re-started, starts up after 3 minutes
	No voltage	check plug, sockets, fuses and electric mains
	Other causes	 If the problem persists, contact the after-sales centre.
The refrigerator unit functions continuously, cooling insufficiently	Room too hot	air the environment
	Dirty condenser	clean the condenser
	Insufficient door sealing	check the gaskets
	Insufficient quantity of refrigerant gas	 Contact the after-sales centre.
	Hot gas valve partially open	 Contact the after-sales centre.
	Resistances always inserted	check timer (only on models with electric defrosting)
	Condenser fan at a standstill	 Contact the after-sales centre.
	Evaporator fan at a standstill	 Contact the after-sales centre.
The refrigerator unit does not stop	Probe faulty	 Contact the after-sales centre.
	Remote-thermostat or thermostat faulty	 Contact the after-sales centre.
Presence of ice inside the evaporator	Drain pipe blocked	disassemble and re-mount the draining unit after having checked cleanliness (only on static model)
	Appliance not level	use the adjustable feet to level
	Hot gas valve failure	 Contact the after-sales centre.
	Resistances not functioning	check defrosting activation (only on models with electric defrosting)
Appliance noise	Persistent vibrations	check there is no contact between the appliance and other objects inside or outside

9.1. Alarms Display

Problem		Causes	Solutions
AL	"AL" flashes on the display and the buzzer emits an intermittent noise	The temperature detected by the evaporator probe is lower than the established value.	 Contact the after-sales centre. <ul style="list-style-type: none"> ➤ Make sure the evaporator fan is operating. ➤ Make sure the system is not discharged.
	Low evaporator temperature alarm		
AH	"AH" flashes on the display and the buzzer emits an intermittent noise	The temperature detected by the cold room probe is higher than the established value.	<ul style="list-style-type: none"> ➤ Check the cold room temperature ➤ Make sure the system is operating correctly.
	High cold room temperature alarm		
id	"id" flashes on the display and the buzzer emits an intermittent noise	The door microswitch input stays open.	 Contact the after-sales centre. <ul style="list-style-type: none"> ➤ Check the door micro ➤ Make sure the door is aligned correctly
	Door microswitch input alarm		
PF	"PF" flashes on the display and the buzzer emits an intermittent noise	There has been a power failure.	<ul style="list-style-type: none"> ➤ Check the electrical system.  To avoid having to memorise power failure alarms repeatedly, turn the tool off before disconnecting the power supply.
	electrical power supply failure alarm		
COH	"COH" flashes on the display and the buzzer emits an intermittent noise	The temperature detected by the condenser probe is higher than the established value.	 Contact the after-sales centre. <ul style="list-style-type: none"> ➤ Air the environment. ➤ Clean the condenser.
	Condenser temperature alarm		
CSd	"CSd" flashes on the display and the buzzer emits an intermittent noise	The temperature detected by the condenser probe is higher than the established value.	 Contact the after-sales centre. <ul style="list-style-type: none"> ➤ Clean the condenser. ➤ Check that the condenser fans are functioning correctly.
	Condenser fan blocked alarm		

9.2. Faults Display

	Problem	Causes	Solutions
Pr1	"Pr1" flashes on the display and the buzzer emits an intermittent noise	<ul style="list-style-type: none"> ➤ The wrong type of probe is installed. ➤ The probe is faulty. ➤ The probe – circuit board connection is incorrect. ➤ The temperature detected by the probe is out of the limits accepted by the cold room probe in use 	<p>✘ Contact the after-sales centre.</p> <ul style="list-style-type: none"> ➤ Check that the cold room probe is the NTC type. ➤ Check the integrity of the cold room probe. ➤ Check correctness of the instrument - probe connection. ➤ Check that the temperature in proximity of the cold room probe is not out of the accepted limits
	Cold room probe error		
Pr2	"Pr2" flashes on the display and the buzzer emits an intermittent noise		
	Evaporator probe error		
Pr3	"Pr3" flashes on the display and the buzzer emits an intermittent noise		
	condenser probe error		
rtc	The letters " rtc " (clock error) will flash on the screen	The current time setting has been deleted.	<ul style="list-style-type: none"> ➤ Set the day and time.

10. TECHNICAL NOTES

10.1. Accessory wheels assembly kit

- Unscrew the feet (1) until they are removed completely
- Fix the wheel (2) and base (3) board to the bottom of the cabinet using the screws supplied.
- The screws of each wheel can be inserted in the envisioned 4 Ø 6mm holes.

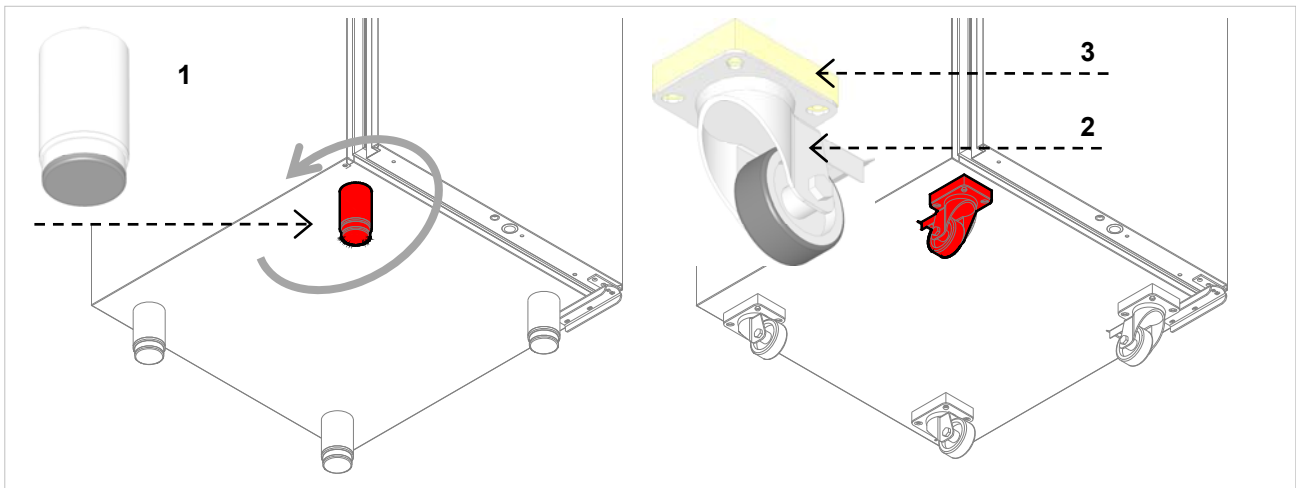

10.2. Reversibility of the Doors

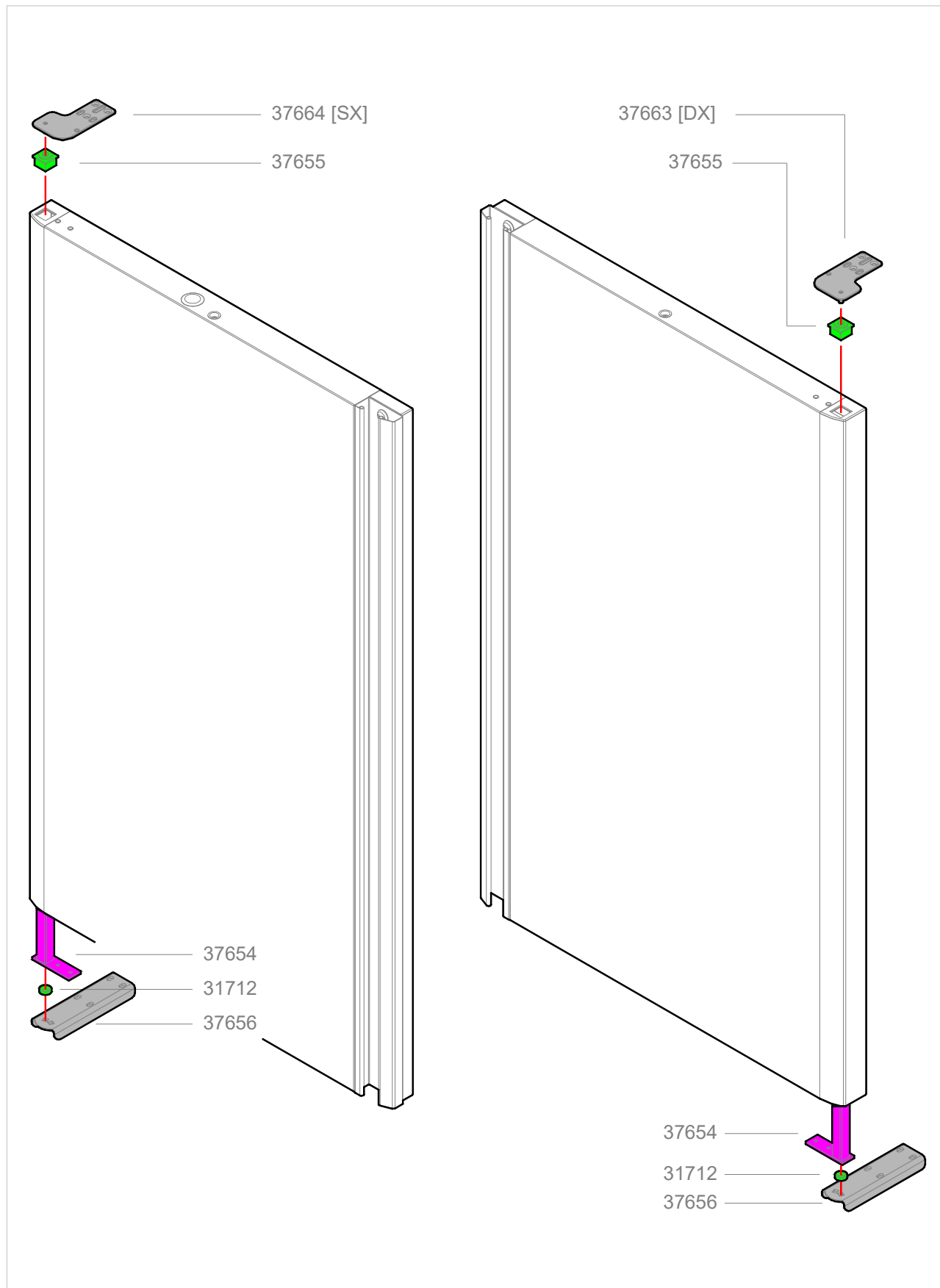

GB

GB

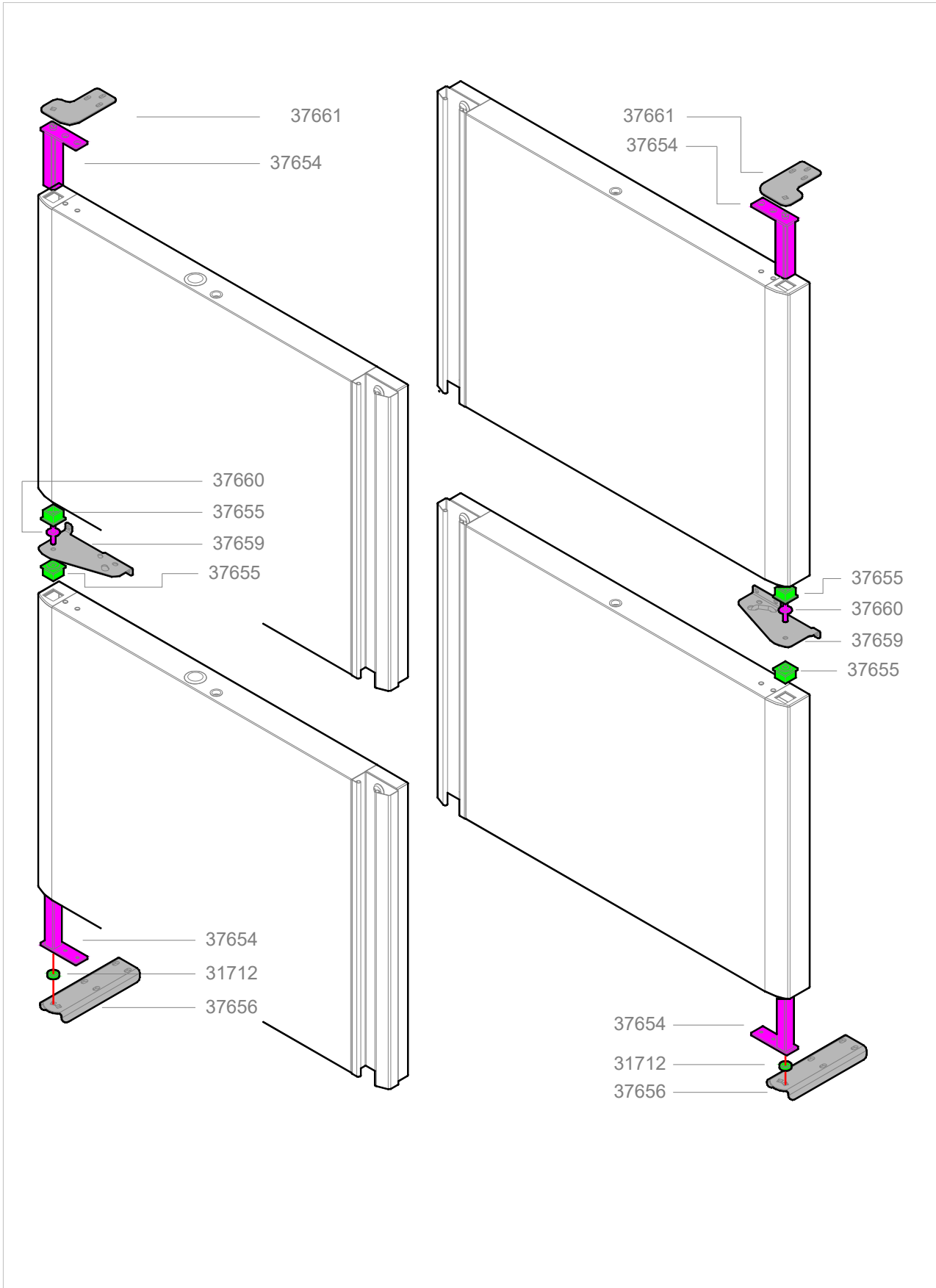

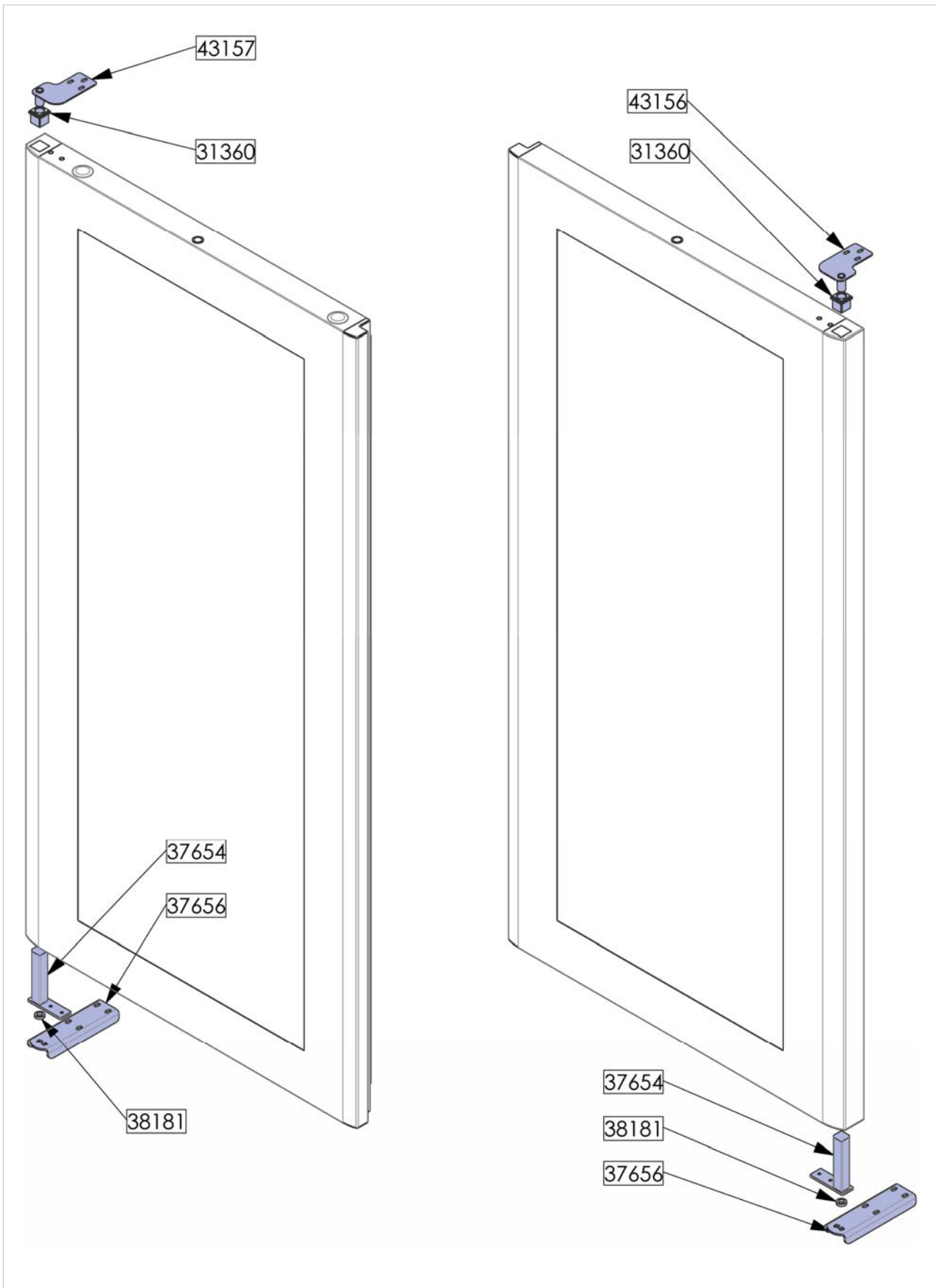





















10.3. Parameter settings

The operating parameters, modifiable using the keypad, are divided into two types: frequent (type F) and configuration (type C). Access to the latter is protected by password (default= 22) to prevent accidental or unauthorised modifications.

Accessing the type F parameters:

- Press the  button for more than 3 s (if there are active alarms, mute the buzzer). The display shows the parameter code 'PS' (password);
- use the  and  buttons to scroll the parameters. The LED corresponding to the category of parameters will be on (see Table).
- press  to display the value associated with the parameter.
- increase or decrease the value using the  and  button respectively.
- press  to temporarily save the new value and display the parameter again.
- repeat the procedure for any other parameters that need to be modified.
- press the  button for more than 3 s to permanently save the parameters and exit the parameter setting procedure.

Accessing the type C parameters:

- Press the  button for more than 3 s (if there are active alarms, mute the buzzer), the display shows the parameter code "PS" (password);
- press the  button to access the password setting.
- use the  and  buttons to scroll the numbers until displaying **22** (password to access the parameters);
- press the  button to confirm the password.
- use the  and  buttons to scroll the parameters. The LED corresponding to the category of parameters will be on (see Table)
- press  to display the value associated with the parameter.
- increase or decrease the value using the  and  button respectively.
- press  to temporarily save the new value and display the parameter again.
- repeat the procedure for any other parameters that need to be modified.
- press the  button for more than 3 s to permanently save the parameters and exit the parameter setting procedure.

Warnings: if no button is pressed for 60 s, all the changes made to the parameters, temporarily saved in the RAM, will be cancelled and the previous settings restored.

If power is disconnected from the instrument before saving the settings (pressing the  button for 3 s), all the changes made to the parameters and temporarily saved will be lost.



11. DISPOSAL OF THE APPLIANCE

 This appliance is marked in compliance with the 2002/96/EC European Directive, WASTE ELECTRICAL AND ELECTRONIC EQUIPMENT (WEEE).

 By assuring that this product is disposed of correctly, the user contributes to preventing the potential negative consequences on the environment and health.

The improper disposal of Waste Electrical and Electronic Equipment is liable to punishment under the relevant laws in the countries where the offence is committed.

Waste electrical and Electronic Equipment may contain hazardous substances with potential harmful effects on the environment and human health. You are urged to dispose of them properly.

 The  symbol found on the product or on the accompanying documentation indicates that this product must not be treated as domestic waste but must be taken to suitable collection points for the recycling of electric and electronic appliances.

11.1. Waste storage

At the end of the product life, avoid release to the environment.

Temporary storage of special waste is permitted while waiting for disposal by treatment and/or final collection. Dispose of special waste in accordance with the laws in force with regard to protection of the environment in the country of the user.

 For further information regarding the treatment, recovery and recycling of this product, contact the relevant local office, the domestic waste collection service or the shop where the product was purchased.

11.2. Equipment disassembly procedure

 Dismantling operations should be carried out by qualified personnel.

 If the equipment uses R290 cooling gas, every possible precaution must be taken to avoid any danger linked to the flammability of this gas.

 The doors should be removed before disposal.

 Make the appliance totally unusable by removing the power cable and any door locking mechanisms in order to avoid the risk of anyone being trapped inside.

 If the equipment uses R452A, R134a refrigerant or other greenhouse gas (Fgas), it is mandatory to recover and dispose of the refrigerant as prescribed in the country of destination of the equipment.

 Dismantle the refrigerator grouping together the components according to their chemical nature. The compressor contains lubricating oil and refrigerant, which may be recycled. The refrigerator components are considered special waste, which can be assimilated with domestic waste.

12. TECHNICAL DATA SHEET REFRIGERANT R134a / R452A

Below find the components of the fluid: **R452A**

Name	%	Chemical Formula
HFC-125	59%	C ₂ H ₅ F
HFC-1234yf	30%	C ₃ H ₂ F ₄
HFC-32	11%	CH ₂ F ₂

IDENTIFICATION OF DANGERS

The rapid evaporation of the liquid can cause freezing. The inhalation of high concentrations of vapour can cause irregular heartbeat, short-term narcotic effects (including vertigo, headache and mental confusion), fainting and death.

- Effects to the eyes: Freezing or cold burns caused by contact with the liquid.

- Effects on the skin: Freezing or cold burns caused by contact with the liquid.
- Effects of ingestion. Ingestion is not considered a means of exposure

FIRST AID

Eyes: In the case of contact, wash the eye well using a large amount of water for at least 15 minutes. Consult a doctor.

Effects on the skin: Wash with water for at least 15 minutes after excessive contact. If necessary, cure freezing by gently warming the area in question. Consult a doctor in the case of irritation.

Ingestion: Ingestion is not considered a means of exposure.

Inhalation: If large concentrations are inhaled, go into the open air. Keep the person calm. If the person cannot breathe, perform artificial respiration. If respiration is difficult, apply oxygen. Consult a doctor.

13. TECHNICAL DATA SHEET REFRIGERANT R290

Name	Chemical Formula
HC-290	CH ₃ CH ₂ CH ₃

IDENTIFICATION OF DANGERS

- Extremely flammable
- Liquefied gas



GHS02



GHS04

FIRST AID

Inhalation: The intervention of a doctor is recommended. In high concentrations, it can cause asphyxiation. Symptoms can include loss of mobility and/or consciousness. Symptoms can also include dizziness, headache, nausea, and loss of coordination. Move the victim to an uncontaminated area wearing self-contained breathing apparatus. Keep the patient relaxed and warm.

Give artificial respiration if breathing stops.

Skin and eyes contact: Wash with water for at least 15 minutes. Remove any contaminated clothing.

Ingestion: No action is necessary. Ingestion is not considered a means of exposure.