

07/2018

Mod: ICE95A-R2

Production code: CB955A HC



Diamond
catering equipment

AUTOMATIC ICE-CUBE MAKER

CLEANING AND SANITIZING MANUAL

FOR AUTHORIZED MAINTENANCE PERSONNEL ONLY

24768 ed. 10-2007



1

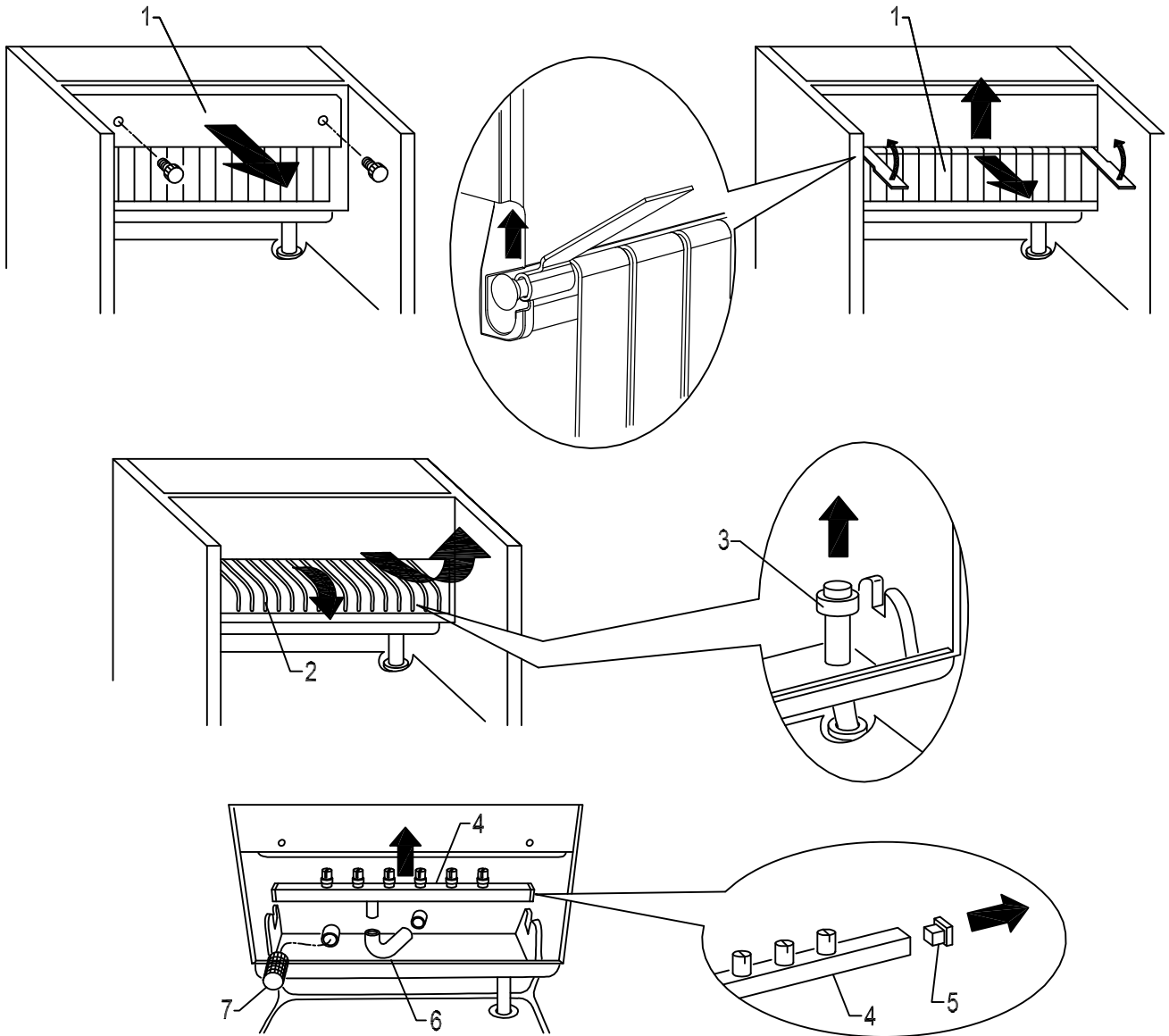

2

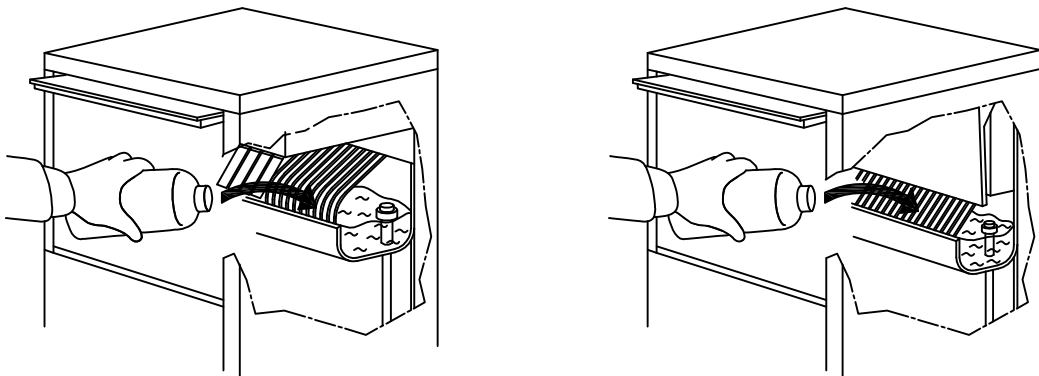

24 	21 - 28	33 - 46	65 - 90	105 - 155
	2	3	5	9

3

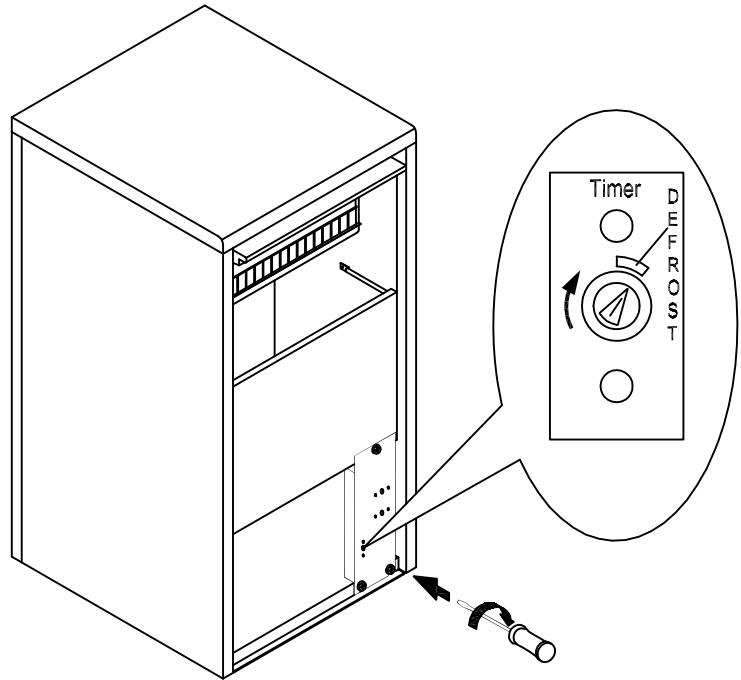
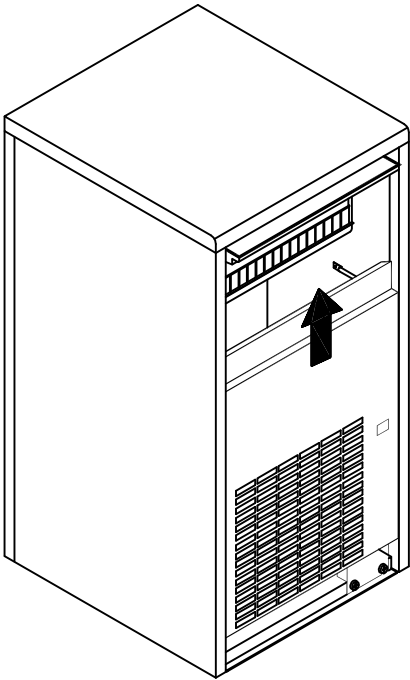
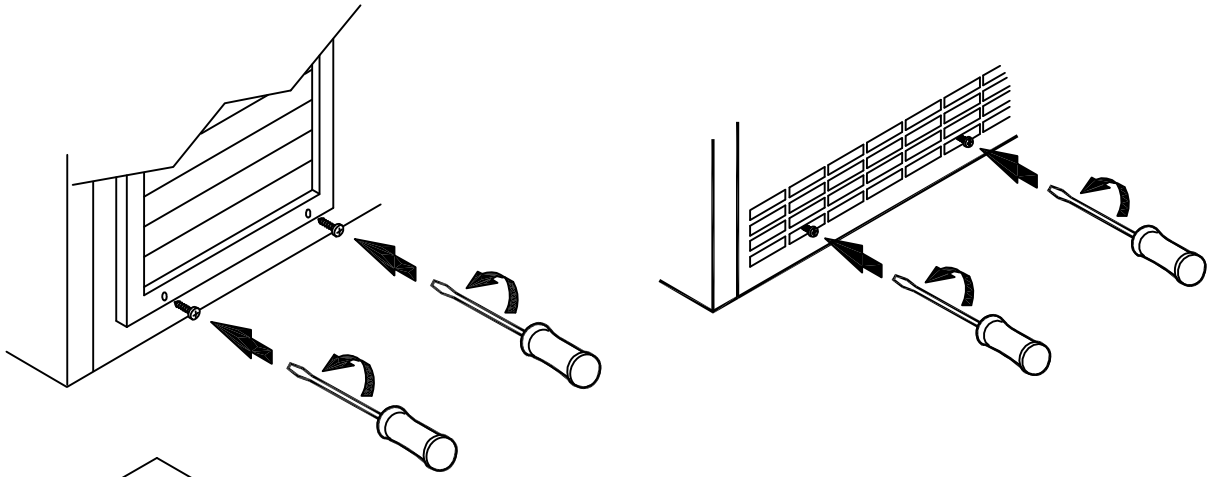

4

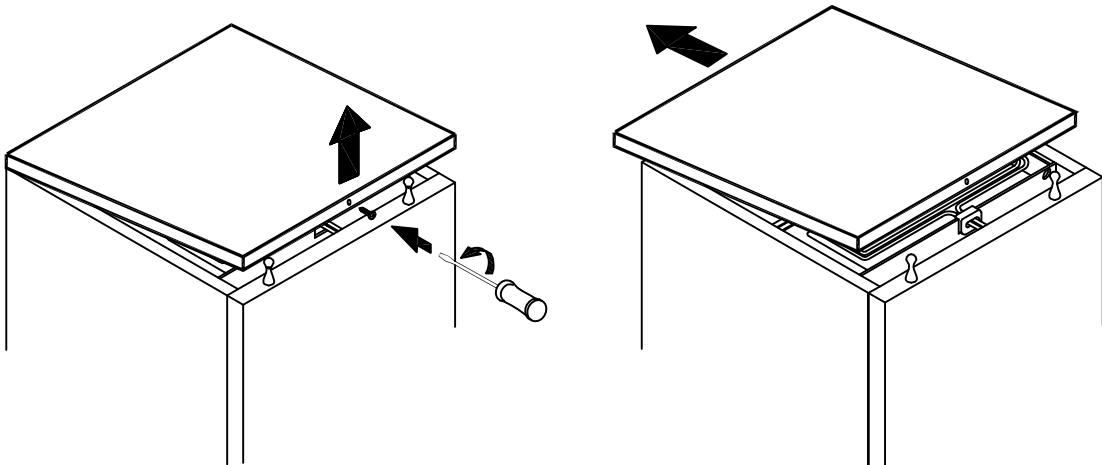

5

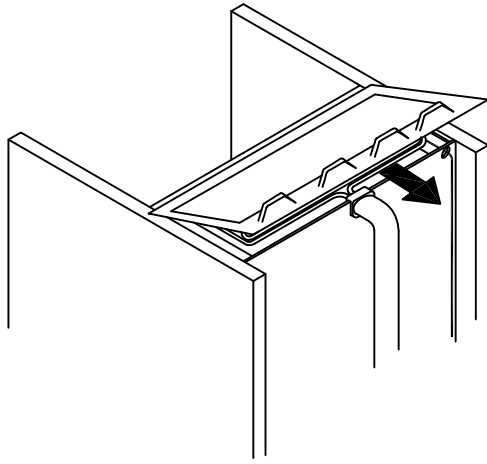

6

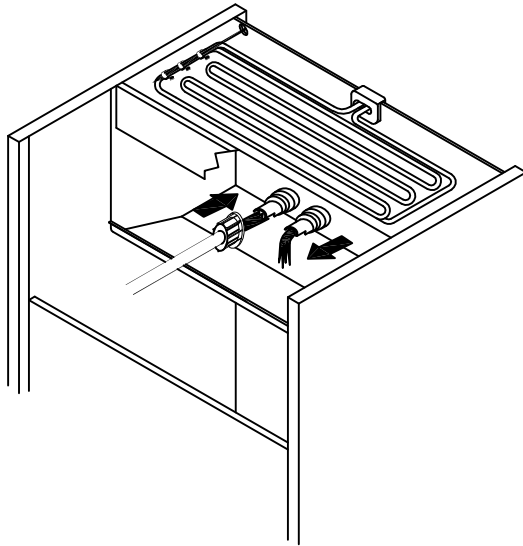

7

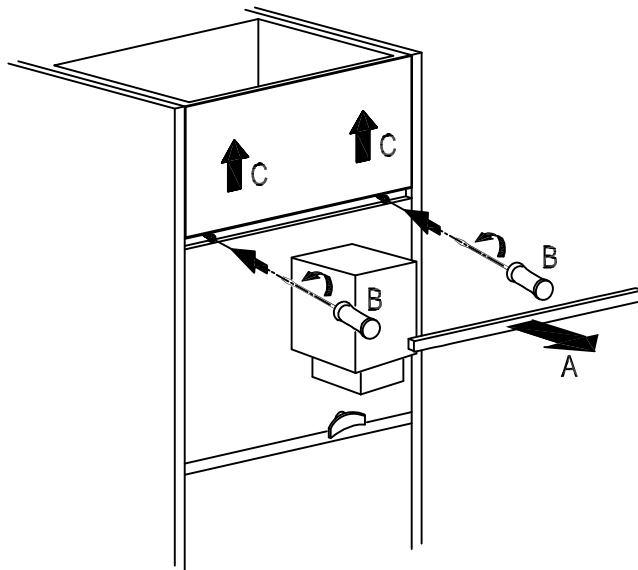

8

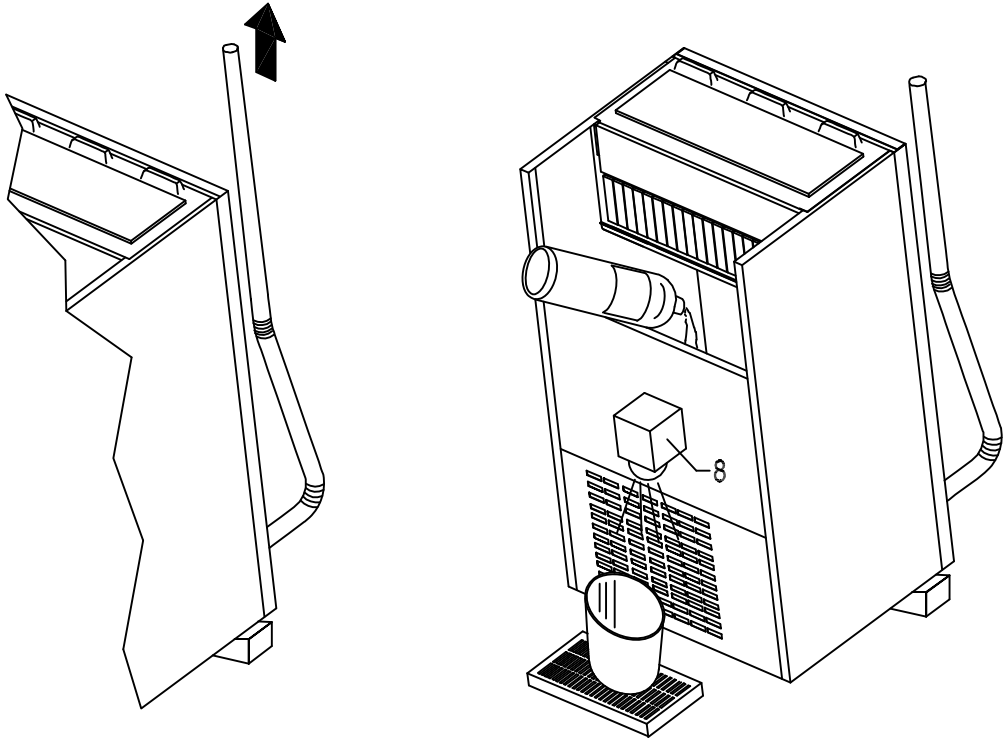

9

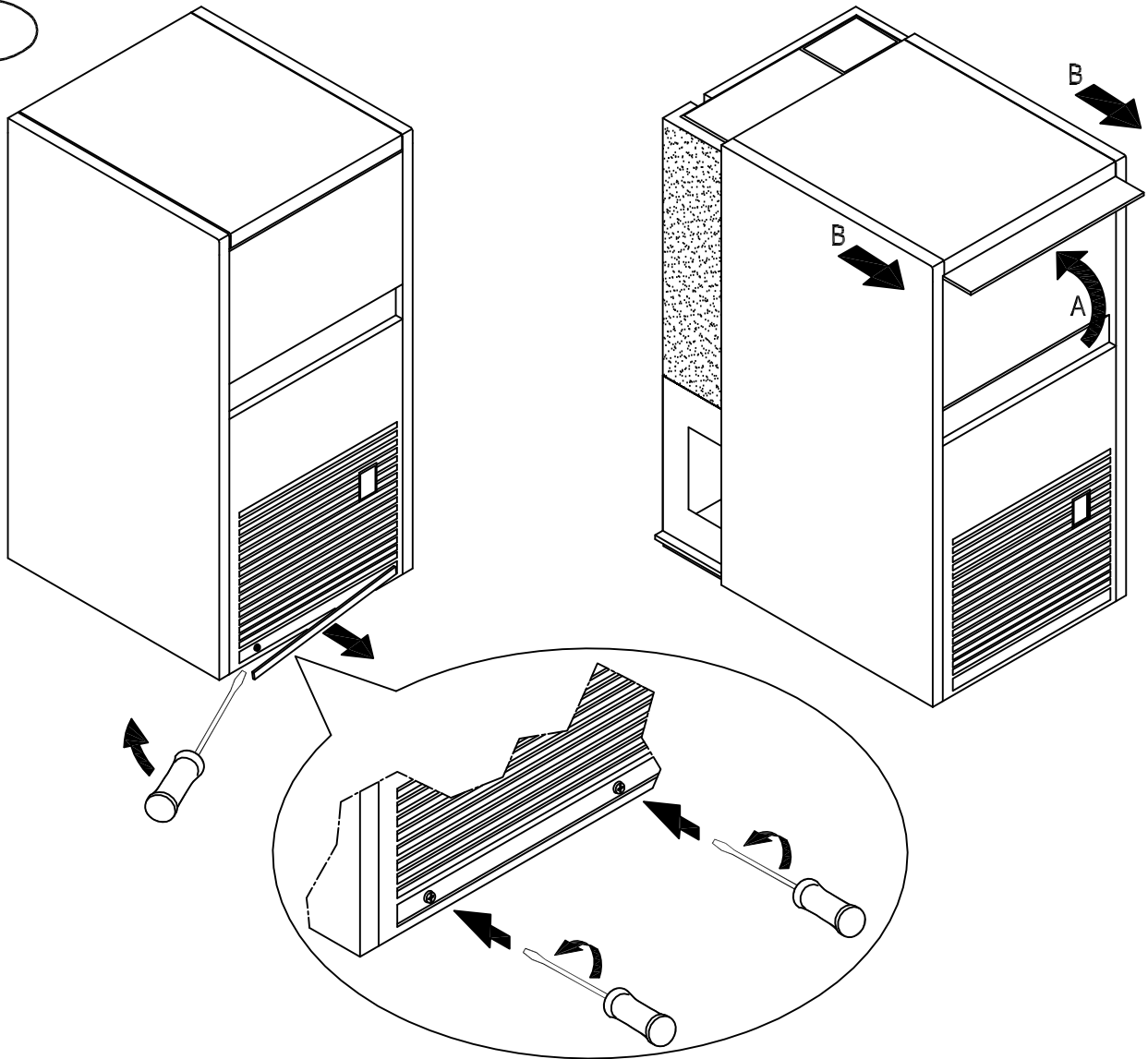

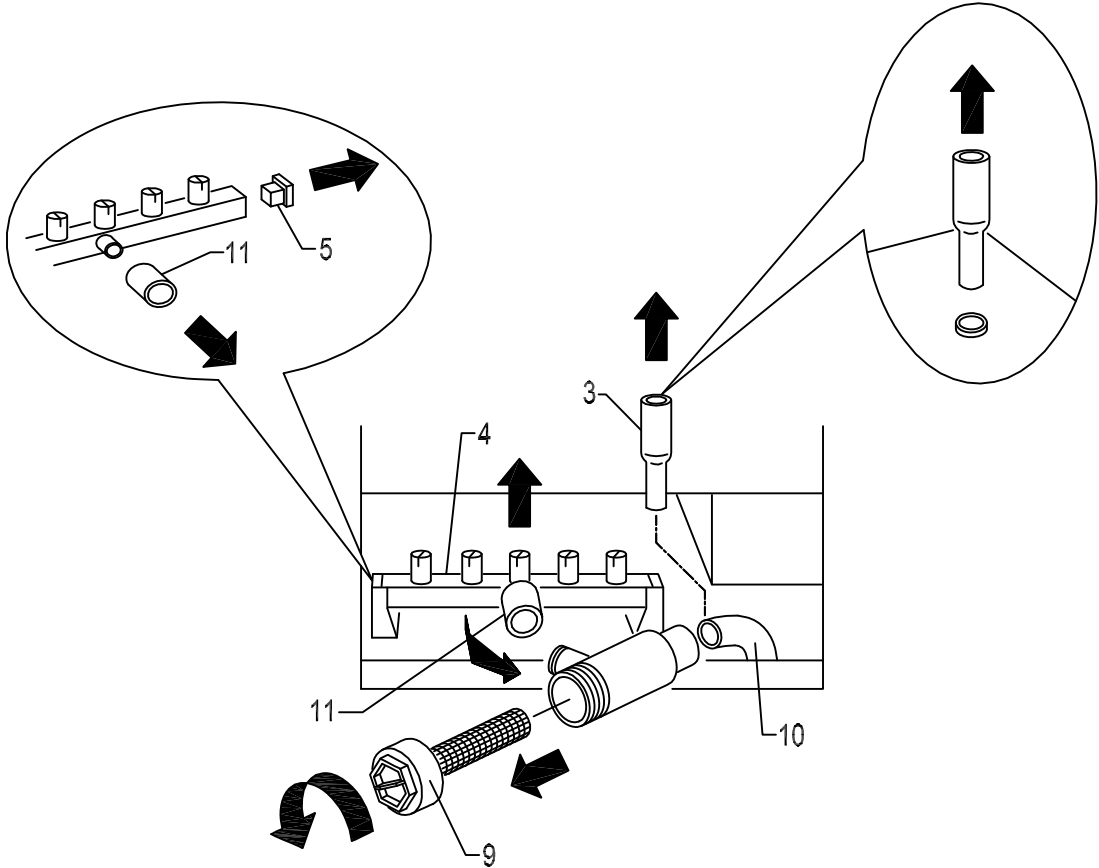
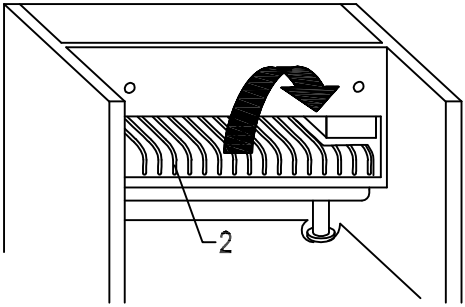
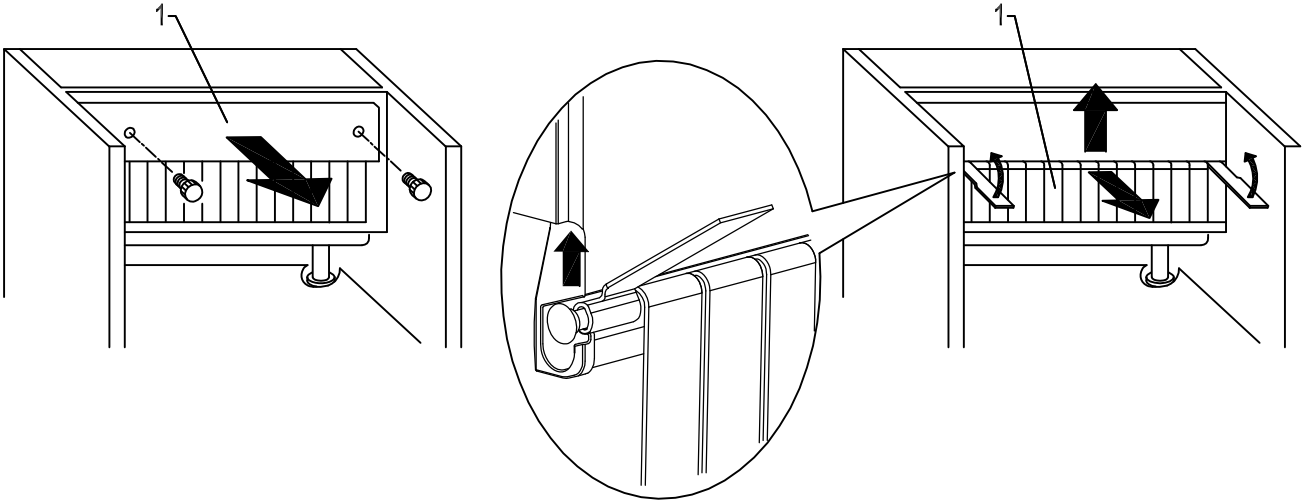

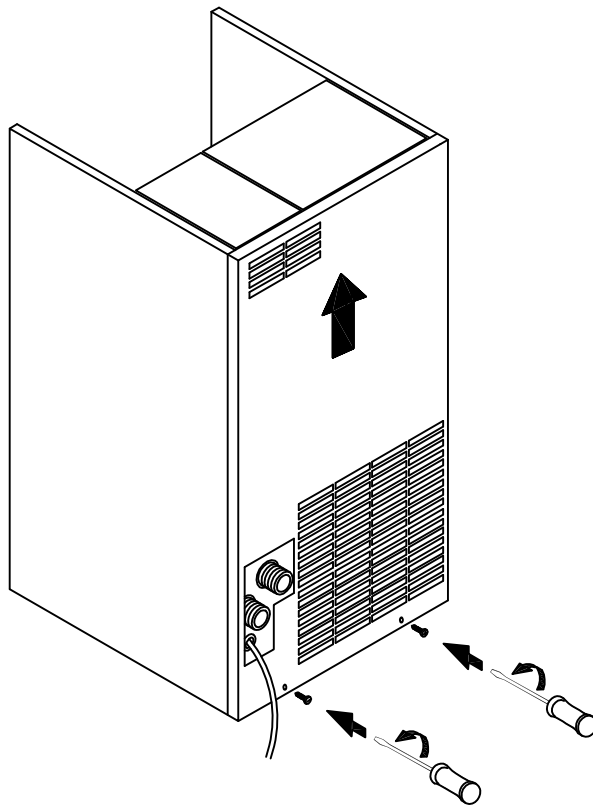
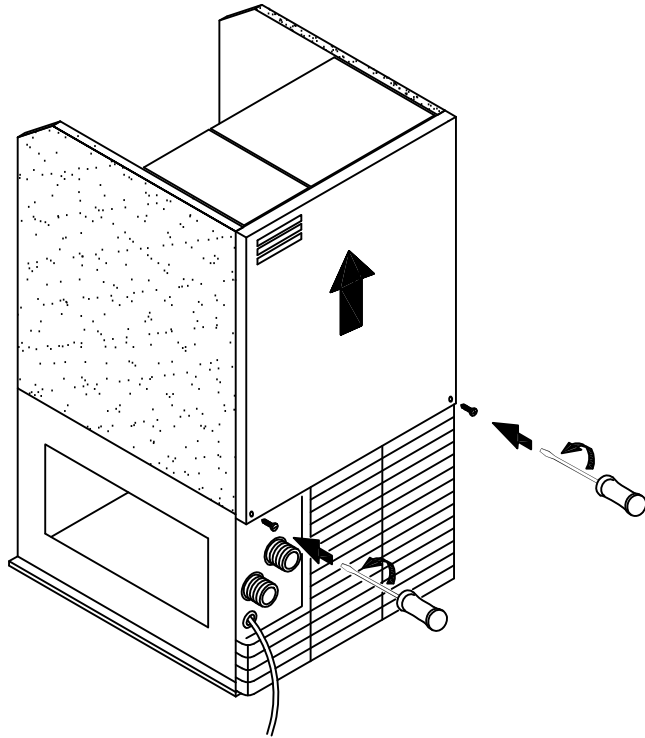

12

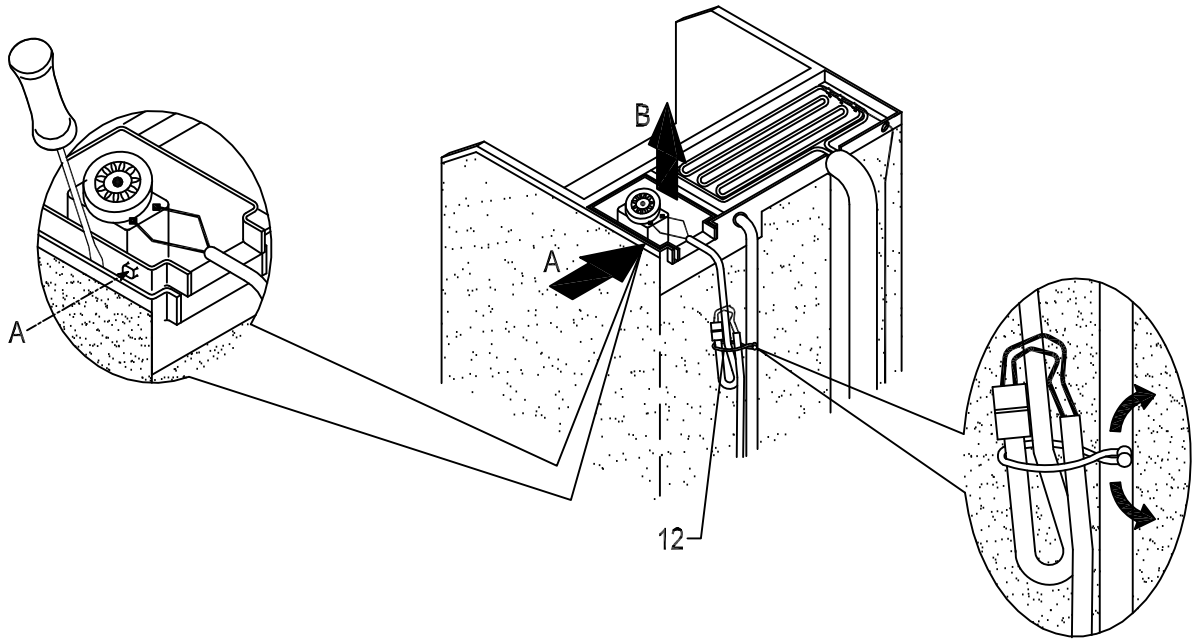

13

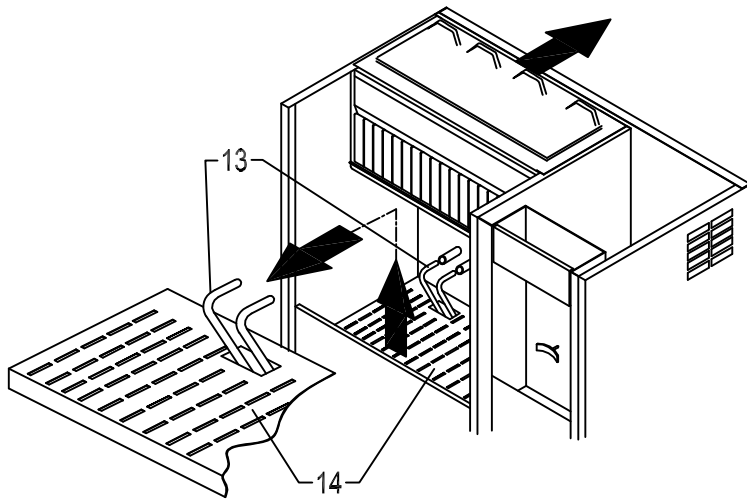

14

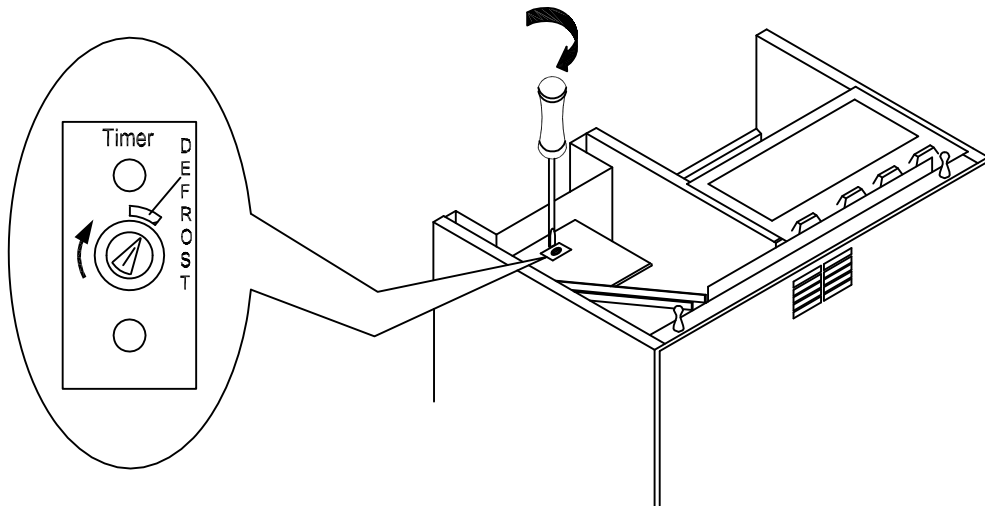

15

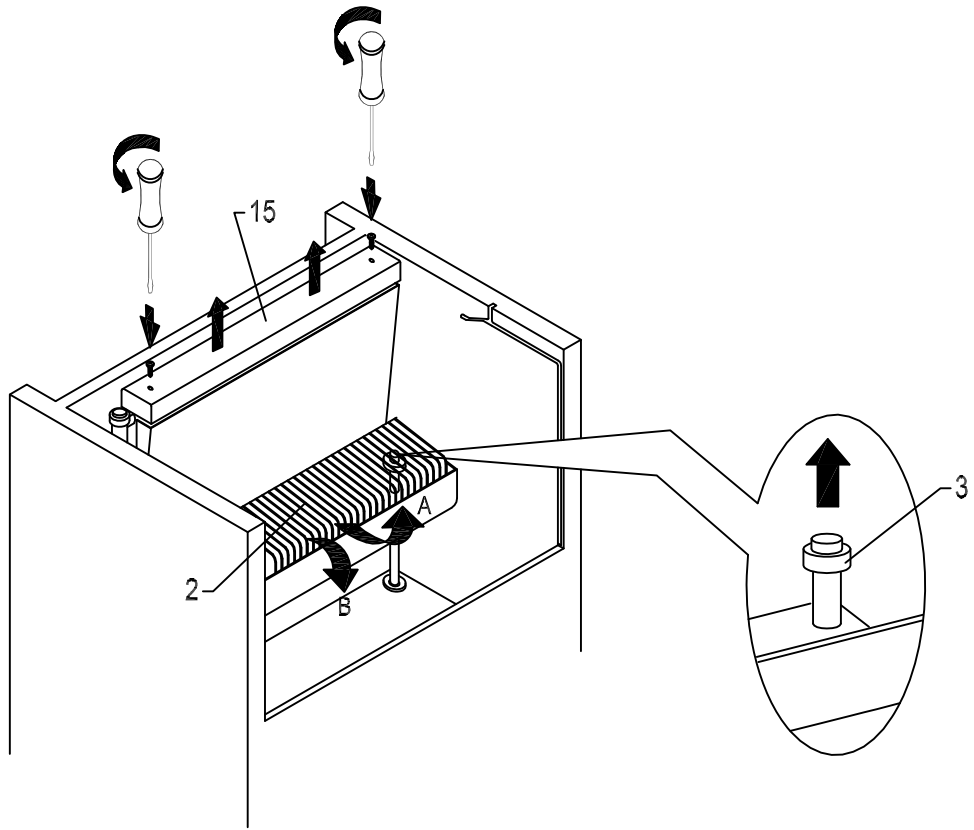

16

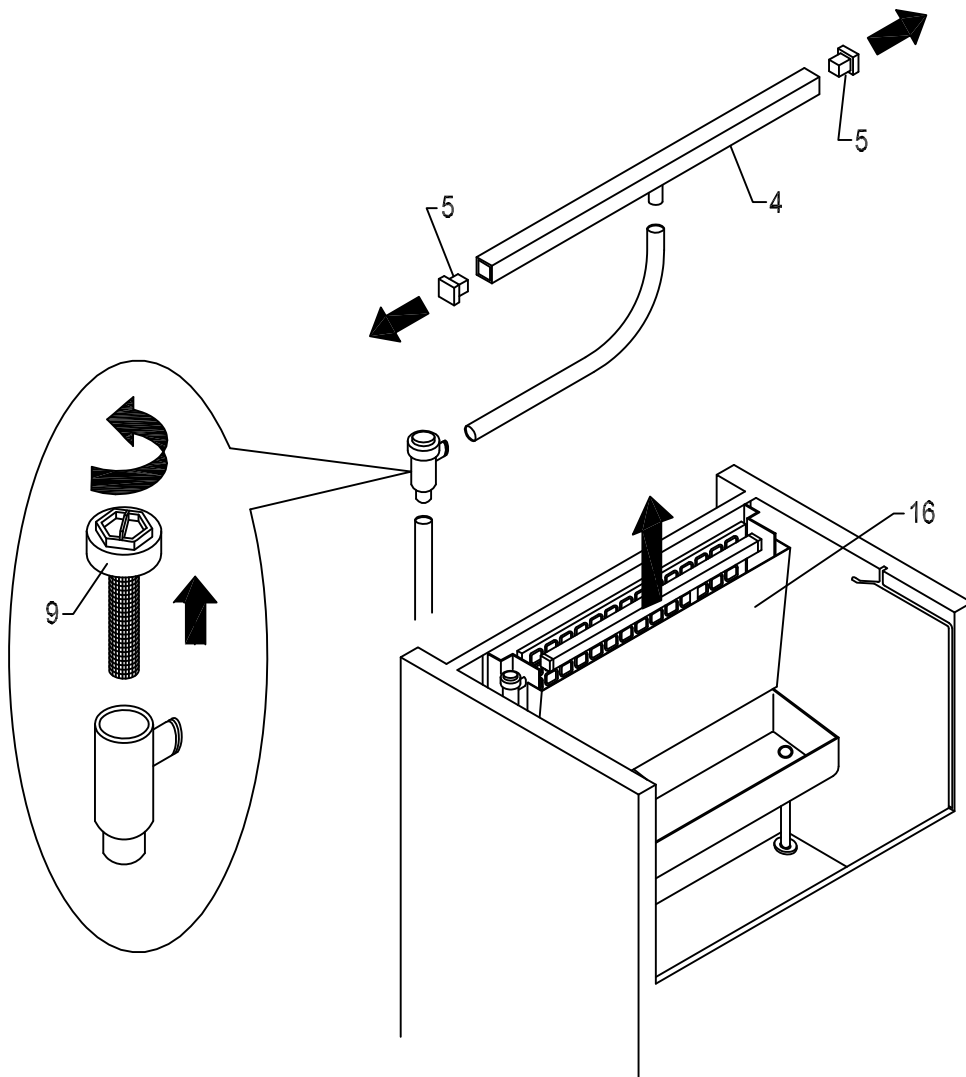

TABLE of CONTENTS

- 1 RECOMMENDATIONS
- 2 CLEANING
- 3 SANITIZING
- 4 NOTE FOR ICE MAKER WITH CONTINUOUS DELIVERY
- 5 NOTE FOR ICE MAKER WITH ABS FINISHING
- 6 NOTE FOR ICE MAKER WITH DAILY PRODUCTION OF 21 kg
- 7 NOTE FOR ICE MAKER WITH COLD WATER DISPENSER
- 8 NOTE FOR ICE MAKER WITH VERTICAL EVAPORATOR SYSTEM

The figures in this manual are of a general nature. Some details may therefore differ, depending on the specific model.

The Manufacturer declines all liability for any inaccuracies in this cleaning and sanitizing manual due to printing or transcription errors. The Manufacturer also reserves the right to make any modifications to the products that may be necessary or useful, also in the interest of the user, without impairing the products' essential features of functionality and safety.

1 RECOMMENDATIONS

This cleaning and sanitizing manual forms an integral part of the ice-cube maker (also more simply called “appliance” in the text) and must be kept for possible future consultation.

In the event of the appliance being sold or transferred to another person, this manual must be handed over to the new user, in order to enable him to become familiar with the operation of the equipment and the corresponding advice and recommendations.

This cleaning and sanitizing manual does not replace the instruction book supplied with the ice maker, which should be referred to for all subjects not covered by this manual; in particular, please refer to the instruction book for the start-up procedure, connection of the appliance to the electricity mains and water supply, and cleaning of components not expressly mentioned in the cleaning and sanitizing manual.

The frequency of cleaning and sanitizing operations can vary, depending on:

- temperature and environmental conditions
- temperature and quality of water (hardness, presence of grit, etc.)
- quantity of ice produced, or time of use of ice-cube maker
- periods of non-use of ice-cube maker

TO ENSURE CORRECT CLEANING AND SANITIZING OF THE ICE-CUBE MAKER, PERFORM THE OPERATIONS DESCRIBED IN THIS MANUAL AT LEAST ONCE A MONTH.

!! IMPORTANT:

- the operations described in this manual must only be performed by skilled, authorized personnel
- the appliance must be installed in a hygienically clean location; avoid premises such as cellars and storerooms, because poor hygiene promotes the formation and proliferation of bacteria in the ice-cube maker
- a cleaning and sanitizing kit specifically designed for this appliance is available from your dealer
- do not use corrosive substances to remove limestone from the appliance, because this will invalidate the guarantee, and may cause serious damage to the materials and components of the appliance
- gloves suitable to protect against cuts must be worn when performing all operations involving handling of sheet metal parts in particular
- gloves suitable to protect the skin against the substances used must be worn when performing all cleaning and sanitizing operations
- wear suitable goggles during cleaning and sanitizing operations to protect the eyes against splashes of the substances used
- take care not to spill water or solutions on the wiring or the power cable

2 CLEANING

1. wait for ice cubes to drop, switch off appliance, **disconnect from the electricity mains supply** and open door
2. remove all ice from container
3. remove (Fig. 1) flag support assembly (1) and ice-cube slide (2) and extract overflow pipe (3) to drain water present in basin
4. reposition overflow pipe and fill basin with a 25% solution of water and white vinegar. Refer to the table for the amount of solution required, depending on daily output (Fig. 2)
5. reposition ice-cube slide and flag support assembly
6. close door and operate appliance for five one-minute periods, with a five-minute interval between each

!! IMPORTANT:

The pump must be in operation during cleaning cycles (check that water is sprayed). If it is not, immediately adjust the timer regulation screw by turning it clockwise until the indicator on the pin exits from the zone marked DEFROST.

To reach timer, loosen screws in front panel with a Phillips screwdriver, remove front panel by pulling it upwards, and regulate timer with a flat-head screwdriver (Fig. 3).

7. switch off machine and **disconnect it from electricity mains** and water supply

8. remove top of appliance by lifting rear part and releasing it from front hooks (Fig. 4). **NOTE:** on some models the top is secured to the rear panel of the appliance with a screw, which must be removed before lifting the top and repositioned when cleaning and sanitizing operations are finished
9. remove evaporator cover panel (Fig. 5) and clean top part of evaporator, bin, evaporator cover panel and door with water and vinegar solution
10. remove any sediment from evaporator and evaporator cover panel using a brush with soft bristles and a non-abrasive sponge
11. pour plenty of cold water onto the evaporator and with the aid of the brush, direct the sediment removed into the basin beneath, taking care not to obstruct the holes in the base of the evaporator. During cleaning of evaporator, take care:
 - not to bend coils
 - not to detach water supply pipes
 - not to remove evaporator thermostat
12. remove (Fig. 1) and clean with ordinary washing-up liquid:
 - flag support assembly (1)
 - ice-cube slide (2)
 - overflow pipe (3)
 - sprayer bank (4), taking care to remove side caps (5)
 - sprayer bank feed pipe (6)
 - pump filter (7)
13. clean with the same washing-up liquid:
 - evaporator cover panel
 - inner basin
 - bin
 - door
14. thoroughly rinse previously cleaned parts with cold water
15. rinse and refit (Fig. 1):
 - pump filter (7)
 - sprayer bank feed pipe (6)
 - sprayer bank (4), after repositioning side caps (5)
 - overflow pipe (3)
 - evaporator cover panel (Fig. 5)
16. prepare to perform the sanitizing operations described in the next chapter

3 SANITIZING

Use a 200 mg/l solution of sodium hypochlorite and water (or a solution of ½ ounce of normal bleach to 1 gallon of water) or one of the solutions commonly used to disinfect babies' feeding bottles; in this case, check that the sanitizing product is:

- authorized by your country's Ministry of Health
- suitable for use with food machines
- not harmful to the materials and components of this appliance

For the directions for use and concentrations, please refer to those shown on the packaging and recommended by the manufacturer. We recommend using the solution at the temperature of 25°C.

1. fill basin with sanitizing solution. Refer to the table for the amount of solution required, depending on daily production (Fig. 2)
2. refit ice-cube slide (2 in Fig. 1) and flag support assembly (1 in Fig. 1)

!! Before connecting the appliance to the mains electricity supply, ensure that all cables and electrical wiring are perfectly dry.

3. operate ice maker for five one-minute periods, with a five-minute break between them

!! IMPORTANT:

The pump must be in operation during sanitizing cycles (check that water is sprayed). If it is not, immediately adjust timer regulation screw by turning it clockwise until the indicator on the pin exits from the zone marked DEFROST.

To reach timer, loosen screws in front panel with a Phillips screwdriver, remove front panel by pulling it upwards, and regulate timer with a flat-head screwdriver (Fig. 3).

4. switch off machine and **disconnect it from the mains electricity** and water supply
5. remove evaporator cover panel (Fig. 5)
6. pour sanitizing solution onto top part of evaporator, distribute with a brush, and rinse thoroughly with cold water
7. remove (Fig. 1) and immerse in sanitizing solution for 30 minutes:
 - flag support assembly (1)
 - ice-cube slide (2)
 - overflow pipe (3)
 - sprayer bank (4) and side caps (5), after removing them from the bank
 - sprayer bank feed pipe (6)
 - pump filter (7)
 - evaporator cover panel (Fig. 5)
8. wipe container walls and door with sanitizing solution using a sponge and brush
9. drain sanitizing solution remaining in pump body by introducing pressurised water into the suction pipe and checking that the water exits from the delivery pipe (Fig. 6)
10. thoroughly rinse inner basin, door and container with cold water
11. thoroughly rinse ice-cube slide, evaporator cover panel, sprayer bank and the corresponding side caps, flag support assembly, overflow pipe, pump filter and sprayer bank feed pipe under running water
12. refit parts previously removed
13. reposition top, securing it to rear panel with the screw, if present

The ice-cube maker can now be reactivated as specified in the instruction manual.

!! IMPORTANT:

All the ice produced during the first five cycles after cleaning and sanitizing operations must be discarded.

THE FOLLOWING ADDITIONAL OPERATIONS ARE REQUIRED FOR SOME SPECIAL MODELS:

4 NOTE FOR ICE MAKER WITH CONTINUOUS DELIVERY

To access the inner parts, remove top of appliance (Fig. 4), then remove front upper panel as shown in Fig. 7. In addition to the operations described in chapters 2 and 3, the following steps must be taken when cleaning and sanitizing the ice collecting bin (Fig. 8):

1. tilt appliance towards the front by positioning a shim at least 4 cm thick under the back legs
2. position a basin under the ice-cube dispenser pipe (8)
3. raise outlet pipe until it is higher than the appliance
4. pour water and vinegar solution onto ice-cube conveyor screw until solution exits from ice-cube dispenser pipe (8)
5. leave solution in bin for at least 30 minutes, then drain solution and return outlet pipe to its original position
6. wipe ice-cube collection bin walls and conveyor screw with a water and vinegar solution using a sponge and brush; avoid rotations which could damage the drive motor
7. repeat operations 3 to 6 using the sanitizing solution
8. thoroughly rinse walls of ice collection bin with cold water
9. rinse ice-cube conveyor screw and bottom of bin with cold water, allowing it to flow along the ice dispenser pipe (8)
10. drain water remaining on bottom of bin and return outlet pipe to its original position

5 NOTE FOR ICE MAKER WITH ABS FINISHING (Fig. 9)

To access inner basin, evaporator and timer regulation screw:

- remove screw cover
- remove screws with a Phillips screwdriver
- open front door and remove ABS shell

6 NOTE FOR ICE MAKER WITH DAILY PRODUCTION OF 21 kg

Perform cleaning and sanitizing operations as described in chapters 2 and 3.

To reach pump filter (Fig. 10):

- remove flag support assembly (1) and ice-cube slide (2) and extract overflow pipe (3) to drain water present in the basin
- disconnect pump connection pipes (10) and sprayer bank (11)
- unscrew the filter threaded ring nut (9)

To access pump side of inner basin:

- remove rear panel by loosening fixing screws and extracting it upwards (Fig. 11)
- remove pump connector pipe (10 in Fig. 10)
- release pump wiring (12 in Fig. 12) and remove pump assembly located on right-hand side of evaporator by lifting it out of its seating, taking care not to damage the wiring (Fig. 12)
- wipe pump container walls with a water and vinegar solution and sanitizing solution using a sponge; take care not to wet the electrical parts
- at the end of cleaning and sanitizing operations on the basin, refit pump, taking care to connect sprayer bank connector pipe (11 in Fig. 10) and pump connector pipe (10 in Fig. 10) correctly and to re-secure pump wiring (12 in Fig. 12)

7 NOTE FOR ICE MAKER WITH COLD WATER DISPENSER

Perform cleaning and sanitizing operations as described in chapters 2 and 3, also removing the following components for cleaning and sanitizing operations (Fig. 13):

- water cooling coil (13)
- coil cover grille (14)

Thoroughly rinse inside of cooling coil by circulating pressurised cold water through it.

Clean and sanitize cold-water dispenser area.

To access timer regulation screw in models with a 21 kg/24h output (Fig. 14):

- remove screw connecting top to rear panel
- raise rear part of top and release it from front hooks
- regulate timer with a flat-head screwdriver

To access pump filter and pump side of inner basin, see chapter 6.

8 NOTE FOR ICE MAKER WITH VERTICAL EVAPORATOR SYSTEM

Perform cleaning and sanitizing operations as described in chapters 2 and 3, in accordance with the following instructions:

- to remove evaporator cover (15) and ice-cube slide (2) and extract overflow pipe (3), see Fig. 15
- to remove sprayer bank (4) and the corresponding side caps (5), see Fig. 16
- to clean and sanitize pump filter (9 in Fig. 16)
- clean front and back of evaporator using a brush with soft bristles
- clean and sanitize tilting panel (16 in Fig. 16)