













10/2019

Mod: D26/6B

Production code: GH50PTBEC

 Model	D26/6B	
Code Production	GH50PTBEC	
Interface :		



	Overall Dimension (Width-Depth-Height) *open	mm	724x818x1529(2010*)
	Packaging Dimension (WxDxH)	mm	760x840x1520
	Gross weight	Kg	117
	Net weight	Kg	107
	Volume	mc	0,97
	Rack size	mm	500x500
	Max door /hood opening	mm	450
	Max glasses/plate Height	mm	425 / 440
	General construction		double skin
	Door/hood Construction		double skin
	Tank construction		deep drawn
	Tank volume	liter	20
	Tank heating element	W	2.500
	Tank surface strainers		stainless steel
	Wash pump type		double flow
	Wash pump power	W	700
	Wash temperature	°C	55
	Boiler type		without pressure
	Boiler volume	liter	11
	Back-flow system		break tank
	Boiler heating element	W	8.000
	Rinse booster pump		yes
	Rinse booster pump power	W	200
	Rinse temperature	°C	80
	Rinse water consumption	Liter /rack	2,6
	Optimal external water pressure	bar	1 - 4
	Drain system		overflow
	Drain pump		KIT (DPS-LC/4-NP)
	Rinse aid dispenser		YES
	Detergent dispenser		KIT (DD-LC/1-NP)
	Wash cycle	sec	60 - 110 - 150 - continuous
	Water softner	Continuous type	NO
	Electric Power	W	8.700
	Electric Connection	V - ph - Hz	400V 3+N 50Hz
	Fuse	A	16
	Plates racks	Nr	YES
	Flat Rack	Nr	YES
	Cutterly Rack	Nr	YES
	Electric cable		YES
	Drain hose		YES
	Fill hose		YES

A		∅ 35 mm M	A	EXIT	∅ 35 mm M
B		G 3/4" M	B	EXIT	G 3/4" F
C		Power supply			

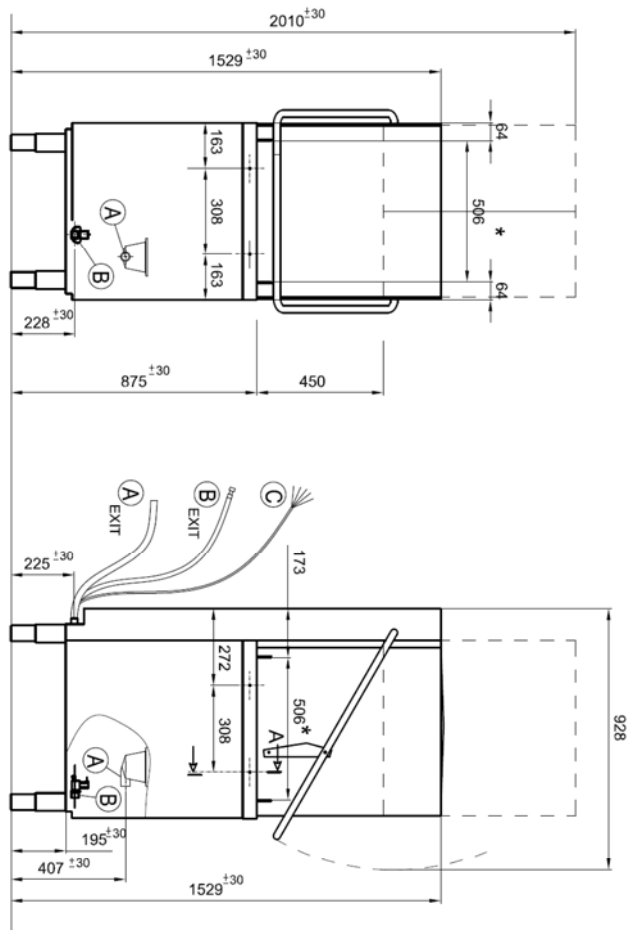
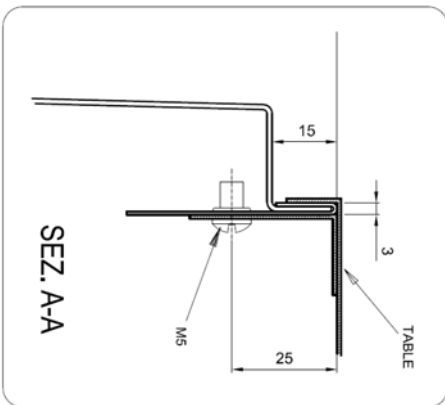
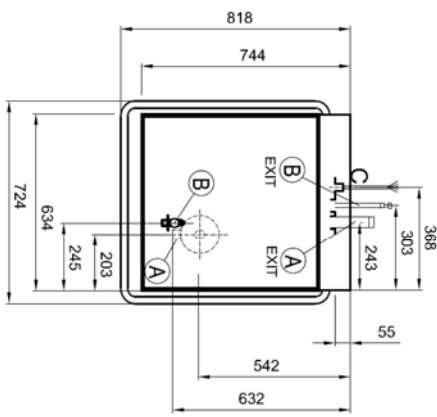

* LUCE UTILE PER CESTELLO
USEFUL SPACE FOR BASKET
LUMIERE UTILE POUR PANIER
NUTZBARER OFFENUNG FÜR KORBE
ABERTURA UTILI PARA CESTO

Installation layout		Hood type	
Designed by:	M.P.UCCI	Date:	30/09/2014
Denomination:		Code:	GH50
		Rev.:	00

